

UMA



SITS

design: Steven Schilte

TECHNICAL SPECIFICATION

PROFILE

COMFORT: standard

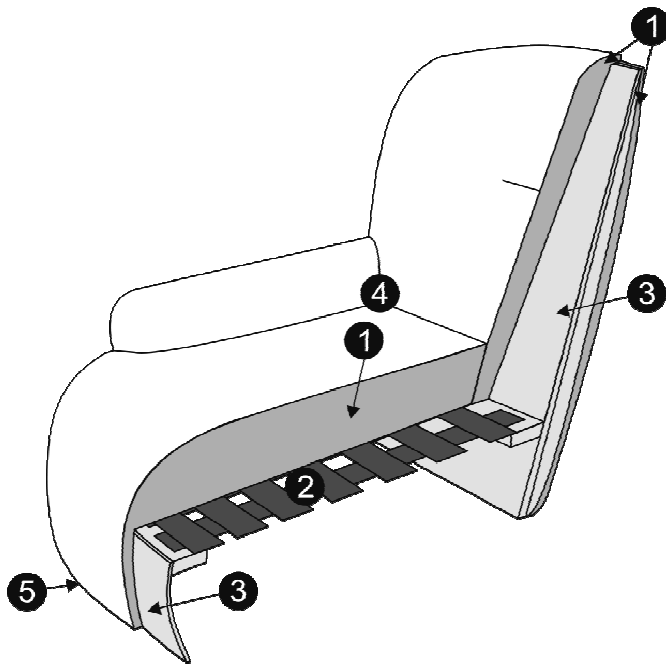

1	polyurethane foam/high resilient polyurethane foam
2	upholstery belts
3	solid wood and wood based elements
4	leather
5	plastic legs or swivel

The producer reserves the right to change construction of products and components used due to improving durability of product and customer satisfaction without any further notice.

UPHOLSTERY:

fabric or leather: FC - fix cover, COMFORT: STD - standard

FEET



UMA



SITS

design: Steven Schilte

Sales Pricelist 2025

UPHOLSTERY: leather: FC - fix cover

COMFORT: STD - standard

Currency:

Valid from: 01.01.2024

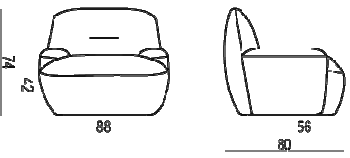
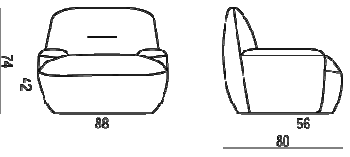
DIMENSION*	DESCRIPTION ARTICLE No	VOL.	WEIGHT	LEATHER USAGE	TOUCH	ANILINE
<p>88x80x74/42</p> 	<p>armchair</p> <p>FC E2577-0000-2S</p>	0,63	30	x	487 425	567 825
<p>88x80x74/42</p> 	<p>armchair with swivel</p> <p>FC E2577-0050-2S</p>	0,63	40	x	542 700	623 100

*Explicit +/- 2 cm tolerance of all elements sizes