

# QUATTRO

LEATHER

home&family



**SITS**  
— comfortable life

design: SITS

## TECHNICAL SPECIFICATION

### PROFILE

COMFORT: standard

|   |  |   |  |   |         |   |   |   |         |   |  |
|---|--|---|--|---|---------|---|---|---|---------|---|--|
| <p><b>FSC</b><br/>www.fsc.org<br/>FSC® C100437<br/>The mark of responsible forestry</p> | <table border="1"> <tr> <td>1</td> <td>polyurethane foam/high resilient polyurethane foam</td> </tr> <tr> <td>2</td> <td>springs</td> </tr> <tr> <td>3</td> <td>FSC® certified solid wood and wood based elements</td> </tr> <tr> <td>4</td> <td>leather</td> </tr> <tr> <td>5</td> <td>FSC® certified solid wood/metal legs (black, , chrome, )</td> </tr> </table> | 1 | polyurethane foam/high resilient polyurethane foam | 2 | springs | 3 | FSC® certified solid wood and wood based elements | 4 | leather | 5 | FSC® certified solid wood/metal legs (black, , chrome, ) |
| 1   | polyurethane foam/high resilient polyurethane foam   |   |  |   |         |   |   |   |         |   |  |
| 2   | springs  |   |  |   |         |   |   |   |         |   |  |
| 3   | FSC® certified solid wood and wood based elements  |   |  |   |         |   |   |   |         |   |  |
| 4   | leather  |   |  |   |         |   |   |   |         |   |  |
| 5   | FSC® certified solid wood/metal legs (black, , chrome, )   |   |  |   |         |   |   |   |         |   |  |

COMFORT: classic

|   |   |   |   |   |         |   |   |   |         |   |  |
|---|---|---|---|---|---------|---|---|---|---------|---|--|
| <p><b>FSC</b><br/>www.fsc.org<br/>FSC® C100437<br/>The mark of responsible forestry</p> | <table border="1"> <tr> <td>1</td> <td>polyurethane foam/high resilient polyurethane foam (extra firm)</td> </tr> <tr> <td>2</td> <td>springs</td> </tr> <tr> <td>3</td> <td>FSC® certified solid wood and wood based elements</td> </tr> <tr> <td>4</td> <td>leather</td> </tr> <tr> <td>5</td> <td>FSC® certified solid wood/metal legs (black, , chrome, )</td> </tr> </table> | 1 | polyurethane foam/high resilient polyurethane foam (extra firm) | 2 | springs | 3 | FSC® certified solid wood and wood based elements | 4 | leather | 5 | FSC® certified solid wood/metal legs (black, , chrome, ) |
| 1   | polyurethane foam/high resilient polyurethane foam (extra firm)   |   |   |   |         |   |   |   |         |   |  |
| 2   | springs   |   |   |   |         |   |   |   |         |   |  |
| 3   | FSC® certified solid wood and wood based elements   |   |   |   |         |   |   |   |         |   |  |
| 4   | leather   |   |   |   |         |   |   |   |         |   |  |
| 5   | FSC® certified solid wood/metal legs (black, , chrome, )  |   |   |   |         |   |   |   |         |   |  |

COMFORT: lux

|   |   |   |  |   |  |
|---|---|---|--|---|--|
| <p><b>FSC</b><br/>www.fsc.org<br/>FSC® C100437<br/>The mark of responsible forestry</p> | <table border="1"> <tr> <td>1</td> <td>polyurethane foam/high resilient polyurethane foam</td> </tr> <tr> <td>2</td> <td>cushion chamber with mix of feather and silicone balls</td> </tr> </table> | 1 | polyurethane foam/high resilient polyurethane foam | 2 | cushion chamber with mix of feather and silicone balls |
| 1   | polyurethane foam/high resilient polyurethane foam  |   |  |   |  |
| 2   | cushion chamber with mix of feather and silicone balls  |   |  |   |  |

# QUATTRO

LEATHER



**SITS**  
— comfortable life

home&family

design: SITS

## TECHNICAL SPECIFICATION

|  |          |  |
|--|----------|--|
|  | <b>3</b> | springs  |
|  | <b>4</b> | FSC® certified solid wood and wood based elements        |
|  | <b>5</b> | leather  |
|  | <b>6</b> | FSC® certified solid wood/metal legs (black, , chrome, ) |

The producer reserves the right to change construction of products and compnents used due to improving durability of product and customer satisfaction without any further notice.

### UPHOLSTERY:

fabric: FC - fix cover, 70/90 - fix seat cushions or 71/91 - loose seat cushions, Comfort: standard, classic or lux  
 leather: FC - fix cover, 71/91 - loose seat cushions, Comfort: standard, classic or lux

### PHOTOS



Total sofa depth after spread: 205 cm

### ARMRESTS

#### ARMREST 400

100 x 20 x 42 cm

available with feet:  
no. 47, no. 51, no. 53,  
no. 61A, no. 145A, no. 176

legs to SB H-100:  
all above

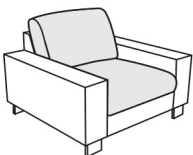

#### ARMREST 450

100 x 12 x 47 cm

available with feet:  
no. 47, no. 51, no. 53,  
no. 61A, no. 145B, no. 176

legs to SB H-100:  
no. 145B, no. 176

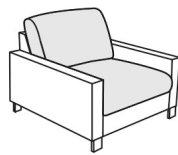

#### ARMREST 460

100 x 27 x 47 cm

available with feet:  
no. 47, no. 51, no. 53,  
no. 61, no. 145A, no. 176

legs to SB H-100:  
all above

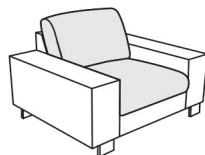

#### ARMREST 480

101 x 17 x 56 cm

available with feet:  
no. 47, no. 51, no. 53,  
no. 145B, no. 176 L-60

legs to SB H-100:  
no. 145B, no 176 L-60

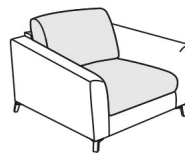

#### ENDPART LEFT

(or RIGHT)  
98 x 55 x 2,5 cm

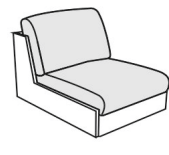

### FEET

# QUATTRO LEATHER

home&family



**SITS**  
— comfortable life

design: SITS

## TECHNICAL SPECIFICATION

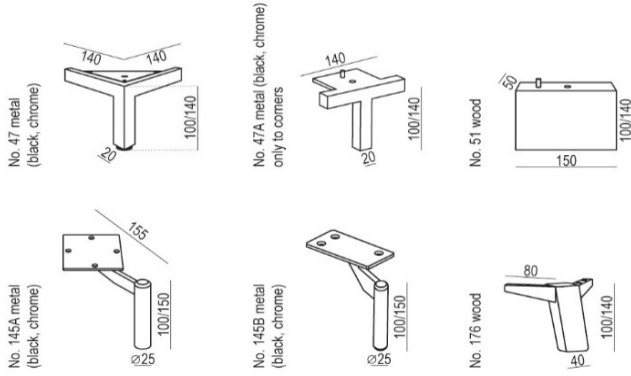

## COLOURS OF WOODEN FEET

oak



bleached oak



walnut



black



# QUATTRO LEATHER



**SITS**  
— comfortable life

home&family

design: SITS

## Sales Pricelist 2025

UPHOLSTERY: leather: FC - fix cover, 71/91 - loose seat cushions  
COMFORT: STD - standard, CLS - classic or LUX

Currency: HUF

Valid from: 01.01.2024

| DIMENSION*<br>for version 71/91 with armrest 400<br>and legs H100 mm | DESCRIPTION<br>ARTICLE No   | VOL.                 | WEIGHT | LEATHER<br>USAGE | MATRIX | TOUCH            | ANILINE          |                  |
|--|---|----------------------|--------|------------------|--------|------------------|------------------|------------------|
| 250x102x78/42  | <b>3 seater XL 71</b>   |                      |        |                  |        |                  |                  |                  |
|  | STD<br>71/91  | <b>E2301-7027-2S</b> | 1,73   | 74               | x      | <b>1 527 600</b> | <b>2 160 750</b> | <b>2 884 350</b> |
|  | CLS<br>71/91  | <b>E2301-7027-2C</b> | 1,73   | 74               | x      | <b>1 396 950</b> | <b>1 974 825</b> | <b>2 638 125</b> |
|  | LUX<br>71/91  | <b>E2301-7027-2L</b> | 1,73   | 74               | x      | <b>1 527 600</b> | <b>2 160 750</b> | <b>2 884 350</b> |
| 220x102x78/42  | <b>3 seater 91</b>  |                      |        |                  |        |                  |                  |                  |
|  | STD<br>71/91  | <b>E2301-9003-2S</b> | 1,53   | 69               | x      | <b>1 316 550</b> | <b>1 899 450</b> | <b>2 517 525</b> |
|  | CLS<br>71/91  | <b>E2301-9003-2C</b> | 1,53   | 69               | x      | <b>1 206 000</b> | <b>1 743 675</b> | <b>2 296 425</b> |
|  | LUX<br>71/91  | <b>E2301-9003-2L</b> | 1,53   | 69               | x      | <b>1 316 550</b> | <b>1 899 450</b> | <b>2 517 525</b> |
| 180x102x78/42  | <b>2 seater 71</b>  |                      |        |                  |        |                  |                  |                  |
|  | STD<br>71/91  | <b>E2301-7002-2S</b> | 1,26   | 58               | x      | <b>1 145 700</b> | <b>1 658 250</b> | <b>2 185 875</b> |
|  | CLS<br>71/91  | <b>E2301-7002-2C</b> | 1,26   | 58               | x      | <b>1 050 225</b> | <b>1 527 600</b> | <b>2 015 025</b> |
|  | LUX<br>71/91  | <b>E2301-7002-2L</b> | 1,26   | 58               | x      | <b>1 145 700</b> | <b>1 658 250</b> | <b>2 185 875</b> |
| 180x102x78/42  | <b>2 seater bed sofa (bed surface: 135 x 195 / depth after spread: 205 cm )</b> |                      |        |                  |        |                  |                  |                  |
|  | STD<br>71/91  | <b>E2301-7001-2S</b> | 1,25   | 87               | x      | <b>2 080 350</b> | <b>2 140 650</b> | <b>2 653 200</b> |
|  | CLS<br>71/91  | <b>E2301-7001-2C</b> | 1,25   | 87               | x      | <b>1 914 525</b> | <b>1 954 725</b> | <b>2 422 050</b> |
| 130x102x78/42  | <b>armchair 91</b>  |                      |        |                  |        |                  |                  |                  |
|  | STD<br>71/91  | <b>E2301-9020-2S</b> | 0,90   | 51               | x      | <b>864 300</b>   | <b>1 241 175</b> | <b>1 623 075</b> |
|  | CLS<br>71/91  | <b>E2301-9020-2C</b> | 0,90   | 51               | x      | <b>798 975</b>   | <b>1 135 650</b> | <b>1 492 425</b> |
|  | LUX<br>71/91  | <b>E2301-9020-2L</b> | 0,90   | 51               | x      | <b>864 300</b>   | <b>1 241 175</b> | <b>1 623 075</b> |
| 110x102x78/42  | <b>armchair 71</b>  |                      |        |                  |        |                  |                  |                  |
|  | STD<br>71/91  | <b>E2301-7004-2S</b> | 0,76   | 44               | x      | <b>804 000</b>   | <b>1 140 675</b> | <b>1 487 400</b> |
|  | CLS<br>71/91  | <b>E2301-7004-2C</b> | 0,76   | 44               | x      | <b>738 675</b>   | <b>1 045 200</b> | <b>1 361 775</b> |
|  | LUX<br>71/91  | <b>E2301-7004-2L</b> | 0,76   | 44               | x      | <b>804 000</b>   | <b>1 140 675</b> | <b>1 487 400</b> |
| 110x155x78/42  | <b>chaiselongue 91 left freestanding</b>  |                      |        |                  |        |                  |                  |                  |

# QUATTRO LEATHER



**SITS**  
— comfortable life

home&family

design: SITS

## Sales Pricelist 2025

UPHOLSTERY: leather: FC - fix cover, 71/91 - loose seat cushions  
COMFORT: STD - standard, CLS - classic or LUX

Currency: HUF

Valid from: 01.01.2024

| DIMENSION*<br>for version 71/91 with armrest 400<br>and legs H100 mm | DESCRIPTION<br>ARTICLE No | VOL.   | WEIGHT | LEATHER<br>USAGE | MATRIX | TOUCH     | ANILINE   |           |
|--|---------------------------|--|--------|------------------|--------|-----------|-----------|-----------|
|  | STD<br>71/91              | E2301-9093-2S                                  | 1,07   | 49               | x      | 1 035 150 | 1 341 675 | 1 743 675 |
|  | CLS<br>71/91              | E2301-9093-2C                                  | 1,07   | 49               | x      | 959 775   | 1 221 075 | 1 608 000 |
|  | LUX<br>71/91              | E2301-9093-2L                                  | 1,07   | 49               | x      | 1 035 150 | 1 341 675 | 1 743 675 |
| <b>110x155x78/42</b>   |                           | <b>chaiselongue 91 right freestanding</b>      |        |                  |        |           |           |           |
|  | STD<br>71/91              | E2301-9092-2S                                  | 1,07   | 49               | x      | 1 035 150 | 1 341 675 | 1 743 675 |
|  | CLS<br>71/91              | E2301-9092-2C                                  | 1,07   | 49               | x      | 959 775   | 1 221 075 | 1 608 000 |
|  | LUX<br>71/91              | E2301-9092-2L                                  | 1,07   | 49               | x      | 1 035 150 | 1 341 675 | 1 743 675 |
| <b>110x182x78/42</b>   |                           | <b>chaiselongue 91 long left freestanding</b>  |        |                  |        |           |           |           |
|  | STD<br>71/91              | E2301-9079-2S                                  | 1,25   | 58               | x      | 1 185 900 | 1 432 125 | 1 879 350 |
|  | CLS<br>71/91              | E2301-9079-2C                                  | 1,25   | 58               | x      | 1 080 375 | 1 316 550 | 1 728 600 |
|  | LUX<br>71/91              | E2301-9079-2L                                  | 1,25   | 58               | x      | 1 185 900 | 1 432 125 | 1 879 350 |
| <b>110x182x78/42</b>   |                           | <b>chaiselongue 91 long right freestanding</b> |        |                  |        |           |           |           |
|  | STD<br>71/91              | E2301-9075-2S                                  | 1,25   | 58               | x      | 1 185 900 | 1 432 125 | 1 879 350 |
|  | CLS<br>71/91              | E2301-9075-2C                                  | 1,25   | 58               | x      | 1 080 375 | 1 316 550 | 1 728 600 |
|  | LUX<br>71/91              | E2301-9075-2L                                  | 1,25   | 58               | x      | 1 185 900 | 1 432 125 | 1 879 350 |
| <b>90x155x78/42</b>  |                           | <b>chaiselongue 71 left freestanding</b>       |        |                  |        |           |           |           |

QUATTRO  
LEATHER



**SITS**  
—comfortable life

home&family

design: SITS

### Sales Pricelist 2025

UPHOLSTERY: leather: FC - fix cover, 71/91 - loose seat cushions  
COMFORT: STD - standard, CLS - classic or LUX

Currency: HUF

Valid from: 01.01.2024

| DIMENSION*<br>for version 71/91 with armrest 400<br>and legs H100 mm | DESCRIPTION<br>ARTICLE No |   | VOL. | WEIGHT | LEATHER<br>USAGE | MATRIX         | TOUCH            | ANILINE          |
|--|---------------------------|---|------|--------|------------------|----------------|------------------|------------------|
|  | STD<br>71/91              | <b>E2301-7084-2S</b>                      | 0,91 | 44     | x                | <b>934 650</b> | <b>1 195 950</b> | <b>1 542 675</b> |
|  | CLS<br>71/91              | <b>E2301-7084-2C</b>                      | 0,91 | 44     | x                | <b>859 275</b> | <b>1 100 475</b> | <b>1 417 050</b> |
|  | LUX<br>71/91              | <b>E2301-7084-2L</b>                      | 0,91 | 44     | x                | <b>934 650</b> | <b>1 195 950</b> | <b>1 542 675</b> |
| <b>90x155x78/42</b>  |                           | <b>chaiselongue 71 right freestanding</b> |      |        |                  |                |                  |                  |
|  | STD<br>71/91              | <b>E2301-7085-2S</b>                      | 0,91 | 44     | x                | <b>934 650</b> | <b>1 195 950</b> | <b>1 542 675</b> |
|  | CLS<br>71/91              | <b>E2301-7085-2C</b>                      | 0,91 | 44     | x                | <b>859 275</b> | <b>1 100 475</b> | <b>1 417 050</b> |
|  | LUX<br>71/91              | <b>E2301-7085-2L</b>                      | 0,91 | 44     | x                | <b>934 650</b> | <b>1 195 950</b> | <b>1 542 675</b> |
| <b>90x90x42</b>  |                           | <b>footstool 90x90</b>                    |      |        |                  |                |                  |                  |
|  | STD<br>71/91              | <b>E2301-9031-2S</b>                      | 0,30 | 27     | x                | <b>482 400</b> | <b>522 600</b>   | <b>628 125</b>   |
|  | CLS<br>71/91              | <b>E2301-9031-2C</b>                      | 0,30 | 27     | x                | <b>442 200</b> | <b>487 425</b>   | <b>577 875</b>   |
|  | LUX<br>71/91              | <b>E2301-9031-2L</b>                      | 0,30 | 27     | x                | <b>482 400</b> | <b>522 600</b>   | <b>628 125</b>   |
| <b>90x53x42</b>  |                           | <b>footstool 90x53</b>                    |      |        |                  |                |                  |                  |
|  | STD<br>71/91              | <b>E2301-9072-2S</b>                      | 0,18 | 20     | x                | <b>371 850</b> | <b>412 050</b>   | <b>487 425</b>   |
|  | CLS<br>71/91              | <b>E2301-9072-2C</b>                      | 0,18 | 20     | x                | <b>351 750</b> | <b>376 875</b>   | <b>457 275</b>   |
|  | LUX<br>71/91              | <b>E2301-9072-2L</b>                      | 0,18 | 20     | x                | <b>371 850</b> | <b>412 050</b>   | <b>487 425</b>   |
| <b>70x53x42</b>  |                           | <b>footstool 70x53</b>                    |      |        |                  |                |                  |                  |
|  | STD<br>71/91              | <b>E2301-7063-2S</b>                      | 0,14 | 17     | x                | <b>331 650</b> | <b>366 825</b>   | <b>437 175</b>   |
|  | CLS<br>71/91              | <b>E2301-7063-2C</b>                      | 0,14 | 17     | x                | <b>311 550</b> | <b>336 675</b>   | <b>396 975</b>   |
|  | LUX<br>71/91              | <b>E2301-7063-2L</b>                      | 0,14 | 17     | x                | <b>331 650</b> | <b>366 825</b>   | <b>437 175</b>   |
| <b>80xØ16x58</b>   |                           | <b>neckrest 80 Ø16</b>                    |      |        |                  |                |                  |                  |
|  | STD<br>71/91              | <b>E2300-1680-4</b>                       | 0,10 | 2      | x                | <b>170 850</b> | <b>180 900</b>   | <b>206 025</b>   |

QUATTRO  
LEATHER



**SITS**  
— comfortable life

home&family

design: SITS

### Sales Pricelist 2025

UPHOLSTERY: leather: FC - fix cover, 71/91 - loose seat cushions  
COMFORT: STD - standard, CLS - classic or LUX

Currency: HUF

Valid from: 01.01.2024

| DIMENSION*<br>for version 71/91 with armrest 400<br>and legs H100 mm              | DESCRIPTION<br>ARTICLE No |                     | VOL. | WEIGHT | LEATHER<br>USAGE | MATRIX         | TOUCH          | ANILINE        |
|---|---------------------------|---------------------|------|--------|------------------|----------------|----------------|----------------|
|  | CLS<br>71/91              | <b>E2300-1680-4</b> | 0,10 | 2      | x                | <b>145 725</b> | <b>165 825</b> | <b>185 925</b> |
|   | LUX<br>71/91              | <b>E2300-1680-4</b> | 0,10 | 2      | x                | <b>170 850</b> | <b>180 900</b> | <b>206 025</b> |

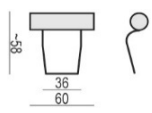
| 60xØ16x58   | neckrest 60 Ø16 |                     |      |   |   |                |                |                |
|---|-----------------|---------------------|------|---|---|----------------|----------------|----------------|
|  | STD<br>71/91    | <b>E2300-1660-4</b> | 0,10 | 2 | x | <b>145 725</b> | <b>165 825</b> | <b>185 925</b> |
|   | CLS<br>71/91    | <b>E2300-1660-4</b> | 0,10 | 2 | x | <b>125 625</b> | <b>135 675</b> | <b>170 850</b> |
|   | LUX<br>71/91    | <b>E2300-1660-4</b> | 0,10 | 2 | x | <b>145 725</b> | <b>165 825</b> | <b>185 925</b> |

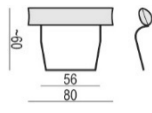
| 80x16x60   | neckrest 80  |                     |      |   |   |                |                |                |
|--|--------------|---------------------|------|---|---|----------------|----------------|----------------|
|  | STD<br>71/91 | <b>E2300-1681-4</b> | 0,10 | 2 | x | <b>180 900</b> | <b>195 975</b> | <b>226 125</b> |
|  | CLS<br>71/91 | <b>E2300-1681-4</b> | 0,10 | 2 | x | <b>165 825</b> | <b>175 875</b> | <b>201 000</b> |

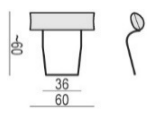
| 60x16x60  | neckrest 60  |                     |      |   |   |                |                |                |
|---|--------------|---------------------|------|---|---|----------------|----------------|----------------|
|  | STD<br>71/91 | <b>E2300-1661-4</b> | 0,10 | 2 | x | <b>165 825</b> | <b>175 875</b> | <b>201 000</b> |
|   | CLS<br>71/91 | <b>E2300-1661-4</b> | 0,10 | 2 | x | <b>135 675</b> | <b>155 775</b> | <b>180 900</b> |

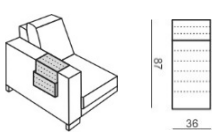
| 35x95   | newspaper holder |                   |      |   |   |                |                |                |
|---|------------------|-------------------|------|---|---|----------------|----------------|----------------|
|  | STD<br>71/91     | <b>E2826-1930</b> | 0,01 | 2 | x | <b>145 725</b> | <b>165 825</b> | <b>185 925</b> |
|   | CLS<br>71/91     | <b>E2826-1930</b> | 0,01 | 2 | x | <b>125 625</b> | <b>135 675</b> | <b>170 850</b> |
|   | LUX<br>71/91     | <b>E2826-1930</b> | 0,01 | 2 | x | <b>145 725</b> | <b>165 825</b> | <b>185 925</b> |

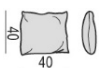
| 40x40   | deco cushion (silicone filling) |                      |      |   |   |                |                |                |
|---|---------------------------------|----------------------|------|---|---|----------------|----------------|----------------|
|  | STD<br>71/91                    | <b>E2826-4040-4P</b> | 0,01 | 1 | x | <b>170 850</b> | <b>185 925</b> | <b>211 050</b> |
|   | CLS<br>71/91                    | <b>E2826-4040-4P</b> | 0,01 | 1 | x | <b>155 775</b> | <b>170 850</b> | <b>190 950</b> |
|   | LUX<br>71/91                    | <b>E2826-4040-4P</b> | 0,01 | 1 | x | <b>170 850</b> | <b>185 925</b> | <b>211 050</b> |

#### elements for building sets:

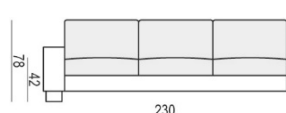
| 230x102x78/42   | 3 seater XL 71 left |                      |      |    |   |                  |                  |                  |
|---|---------------------|----------------------|------|----|---|------------------|------------------|------------------|
|  | STD<br>71/91        | <b>E2301-7042-2S</b> | 1,60 | 63 | x | <b>1 381 875</b> | <b>1 949 700</b> | <b>2 597 925</b> |
|   | CLS<br>71/91        | <b>E2301-7042-2C</b> | 1,60 | 63 | x | <b>1 261 275</b> | <b>1 788 900</b> | <b>2 371 800</b> |
|   | LUX<br>71/91        | <b>E2301-7042-2L</b> | 1,60 | 63 | x | <b>1 381 875</b> | <b>1 949 700</b> | <b>2 597 925</b> |

| 230x102x78/42 | 3 seater XL 71 right |  |  |  |  |  |  |  |
|---------------|----------------------|--|--|--|--|--|--|--|
|---------------|----------------------|--|--|--|--|--|--|--|

QUATTRO  
LEATHER



**SITS**  
— comfortable life

home&family

design: SITS

### Sales Pricelist 2025

UPHOLSTERY: leather: FC - fix cover, 71/91 - loose seat cushions  
COMFORT: STD - standard, CLS - classic or LUX

Currency: HUF

Valid from: 01.01.2024

| DIMENSION*<br>for version 71/91 with armrest 400<br>and legs H100 mm | DESCRIPTION<br>ARTICLE No |  | VOL. | WEIGHT | LEATHER<br>USAGE | MATRIX           | TOUCH            | ANILINE          |
|--|---------------------------|--|------|--------|------------------|------------------|------------------|------------------|
|  | STD<br>71/91              | <b>E2301-7039-2S</b>                   | 1,60 | 63     | x                | <b>1 381 875</b> | <b>1 949 700</b> | <b>2 597 925</b> |
|  | CLS<br>71/91              | <b>E2301-7039-2C</b>                   | 1,60 | 63     | x                | <b>1 261 275</b> | <b>1 788 900</b> | <b>2 371 800</b> |
|  | LUX<br>71/91              | <b>E2301-7039-2L</b>                   | 1,60 | 63     | x                | <b>1 381 875</b> | <b>1 949 700</b> | <b>2 597 925</b> |
| <b>210x102x78/42</b>   |                           | <b>3 seater XL 71 without armrests</b> |      |        |                  |                  |                  |                  |
|  | STD<br>71/91              | <b>E2301-7099-2S</b>                   | 1,46 | 53     | x                | <b>1 221 075</b> | <b>1 718 550</b> | <b>2 286 375</b> |
|  | CLS<br>71/91              | <b>E2301-7099-2C</b>                   | 1,46 | 53     | x                | <b>1 130 625</b> | <b>1 572 825</b> | <b>2 095 425</b> |
|  | LUX<br>71/91              | <b>E2301-7099-2L</b>                   | 1,46 | 53     | x                | <b>1 221 075</b> | <b>1 718 550</b> | <b>2 286 375</b> |
| <b>200x102x78/42</b>   |                           | <b>3 seater 91 left</b>                |      |        |                  |                  |                  |                  |
|  | STD<br>71/91              | <b>E2301-9044-2S</b>                   | 1,39 | 58     | x                | <b>1 155 750</b> | <b>1 678 350</b> | <b>2 231 100</b> |
|  | CLS<br>71/91              | <b>E2301-9044-2C</b>                   | 1,39 | 58     | x                | <b>1 070 325</b> | <b>1 537 650</b> | <b>2 035 125</b> |
|  | LUX<br>71/91              | <b>E2301-9044-2L</b>                   | 1,39 | 58     | x                | <b>1 155 750</b> | <b>1 678 350</b> | <b>2 231 100</b> |
| <b>200x102x78/42</b>   |                           | <b>3 seater 91 right</b>               |      |        |                  |                  |                  |                  |
|  | STD<br>71/91              | <b>E2301-9043-2S</b>                   | 1,39 | 58     | x                | <b>1 155 750</b> | <b>1 678 350</b> | <b>2 231 100</b> |
|  | CLS<br>71/91              | <b>E2301-9043-2C</b>                   | 1,39 | 58     | x                | <b>1 070 325</b> | <b>1 537 650</b> | <b>2 035 125</b> |
|  | LUX<br>71/91              | <b>E2301-9043-2L</b>                   | 1,39 | 58     | x                | <b>1 155 750</b> | <b>1 678 350</b> | <b>2 231 100</b> |
| <b>180x102x78/42</b>   |                           | <b>3 seater 91 without armrests</b>    |      |        |                  |                  |                  |                  |
|  | STD<br>71/91              | <b>E2301-9046-2S</b>                   | 1,25 | 47     | x                | <b>999 975</b>   | <b>1 457 250</b> | <b>1 924 575</b> |
|  | CLS<br>71/91              | <b>E2301-9046-2C</b>                   | 1,25 | 47     | x                | <b>919 575</b>   | <b>1 331 625</b> | <b>1 758 750</b> |
|  | LUX<br>71/91              | <b>E2301-9046-2L</b>                   | 1,25 | 47     | x                | <b>999 975</b>   | <b>1 457 250</b> | <b>1 924 575</b> |
| <b>160x102x78/42</b>   |                           | <b>2 seater 71 left</b>                |      |        |                  |                  |                  |                  |
|  | STD<br>71/91              | <b>E2301-7037-2S</b>                   | 1,12 | 47     | x                | <b>999 975</b>   | <b>1 437 150</b> | <b>1 894 425</b> |
|  | CLS<br>71/91              | <b>E2301-7037-2C</b>                   | 1,12 | 47     | x                | <b>919 575</b>   | <b>1 321 575</b> | <b>1 733 625</b> |
|  | LUX<br>71/91              | <b>E2301-7037-2L</b>                   | 1,12 | 47     | x                | <b>999 975</b>   | <b>1 437 150</b> | <b>1 894 425</b> |
| <b>160x102x78/42</b>   |                           | <b>2 seater 71 right</b>               |      |        |                  |                  |                  |                  |
|  | STD<br>71/91              | <b>E2301-7038-2S</b>                   | 1,12 | 47     | x                | <b>999 975</b>   | <b>1 437 150</b> | <b>1 894 425</b> |
|  | CLS<br>71/91              | <b>E2301-7038-2C</b>                   | 1,12 | 47     | x                | <b>919 575</b>   | <b>1 321 575</b> | <b>1 733 625</b> |
|  | LUX<br>71/91              | <b>E2301-7038-2L</b>                   | 1,12 | 47     | x                | <b>999 975</b>   | <b>1 437 150</b> | <b>1 894 425</b> |
| <b>140x102x78/42</b>   |                           | <b>2 seater 71 without armrests</b>    |      |        |                  |                  |                  |                  |



QUATTRO  
LEATHER



SITS  
— comfortable life

home&family

design: SITS

## Sales Pricelist 2025

UPHOLSTERY: leather: FC - fix cover, 71/91 - loose seat cushions  
COMFORT: STD - standard, CLS - classic or LUX

Currency: HUF

Valid from: 01.01.2024

| DIMENSION*<br>for version 71/91 with armrest 400<br>and legs H100 mm | DESCRIPTION<br>ARTICLE No |                                     | VOL. | WEIGHT | LEATHER<br>USAGE | MATRIX           | TOUCH            | ANILINE          |
|--|---------------------------|-------------------------------------|------|--------|------------------|------------------|------------------|------------------|
|  | STD<br>71/91              | <b>E2301-7045-2S</b>                | 0,98 | 36     | x                | <b>844 200</b>   | <b>1 211 025</b> | <b>1 592 925</b> |
|  | CLS<br>71/91              | <b>E2301-7045-2C</b>                | 0,98 | 36     | x                | <b>773 850</b>   | <b>1 120 575</b> | <b>1 462 275</b> |
|  | LUX<br>71/91              | <b>E2301-7045-2L</b>                | 0,98 | 36     | x                | <b>844 200</b>   | <b>1 211 025</b> | <b>1 592 925</b> |
| <b>110x102x78/42</b>   |                           | <b>armchair 91 left</b>             |      |        |                  |                  |                  |                  |
|  | STD<br>71/91              | <b>E2301-9077-2S</b>                | 0,76 | 38     | x                | <b>1 015 050</b> | <b>1 015 050</b> | <b>1 321 575</b> |
|  | CLS<br>71/91              | <b>E2301-9077-2C</b>                | 0,76 | 38     | x                | <b>929 625</b>   | <b>929 625</b>   | <b>1 211 025</b> |
|  | LUX<br>71/91              | <b>E2301-9077-2L</b>                | 0,76 | 38     | x                | <b>1 015 050</b> | <b>1 015 050</b> | <b>1 321 575</b> |
| <b>110x102x78/42</b>   |                           | <b>armchair 91 right</b>            |      |        |                  |                  |                  |                  |
|  | STD<br>71/91              | <b>E2301-9078-2S</b>                | 0,76 | 38     | x                | <b>1 015 050</b> | <b>1 015 050</b> | <b>1 321 575</b> |
|  | CLS<br>71/91              | <b>E2301-9078-2C</b>                | 0,76 | 38     | x                | <b>929 625</b>   | <b>929 625</b>   | <b>1 211 025</b> |
|  | LUX<br>71/91              | <b>E2301-9078-2L</b>                | 0,76 | 38     | x                | <b>1 015 050</b> | <b>1 015 050</b> | <b>1 321 575</b> |
| <b>90x102x78/42</b>  |                           | <b>armchair 91 without armrests</b> |      |        |                  |                  |                  |                  |
|  | STD<br>71/91              | <b>E2301-9006-2S</b>                | 0,63 | 27     | x                | <b>718 575</b>   | <b>793 950</b>   | <b>1 025 100</b> |
|  | CLS<br>71/91              | <b>E2301-9006-2C</b>                | 0,63 | 27     | x                | <b>663 300</b>   | <b>723 600</b>   | <b>934 650</b>   |
|  | LUX<br>71/91              | <b>E2301-9006-2L</b>                | 0,63 | 27     | x                | <b>718 575</b>   | <b>793 950</b>   | <b>1 025 100</b> |
| <b>90x102x78/42</b>  |                           | <b>armchair 71 left</b>             |      |        |                  |                  |                  |                  |
|  | STD<br>71/91              | <b>E2301-7052-2S</b>                | 0,63 | 33     | x                | <b>648 225</b>   | <b>919 575</b>   | <b>1 190 925</b> |
|  | CLS<br>71/91              | <b>E2301-7052-2C</b>                | 0,63 | 33     | x                | <b>597 975</b>   | <b>839 175</b>   | <b>1 085 400</b> |
|  | LUX<br>71/91              | <b>E2301-7052-2L</b>                | 0,63 | 33     | x                | <b>648 225</b>   | <b>919 575</b>   | <b>1 190 925</b> |
| <b>90x102x78/42</b>  |                           | <b>armchair 71 right</b>            |      |        |                  |                  |                  |                  |
|  | STD<br>71/91              | <b>E2301-7053-2S</b>                | 0,63 | 33     | x                | <b>648 225</b>   | <b>919 575</b>   | <b>1 190 925</b> |
|  | CLS<br>71/91              | <b>E2301-7053-2C</b>                | 0,63 | 33     | x                | <b>597 975</b>   | <b>839 175</b>   | <b>1 085 400</b> |
|  | LUX<br>71/91              | <b>E2301-7053-2L</b>                | 0,63 | 33     | x                | <b>648 225</b>   | <b>919 575</b>   | <b>1 190 925</b> |
| <b>70x102x78/42</b>  |                           | <b>armchair 71 without armrests</b> |      |        |                  |                  |                  |                  |
|  | STD<br>71/91              | <b>E2301-7005-2S</b>                | 0,49 | 23     | x                | <b>487 425</b>   | <b>683 400</b>   | <b>889 425</b>   |
|  | CLS<br>71/91              | <b>E2301-7005-2C</b>                | 0,49 | 23     | x                | <b>457 275</b>   | <b>633 150</b>   | <b>814 050</b>   |
|  | LUX<br>71/91              | <b>E2301-7005-2L</b>                | 0,49 | 23     | x                | <b>487 425</b>   | <b>683 400</b>   | <b>889 425</b>   |
| <b>110x182x78/42</b>   |                           | <b>chaiselongue 91 long left</b>    |      |        |                  |                  |                  |                  |

# QUATTRO LEATHER



**SITS**  
— comfortable life

home&family

design: SITS

## Sales Pricelist 2025

UPHOLSTERY: leather: FC - fix cover, 71/91 - loose seat cushions  
COMFORT: STD - standard, CLS - classic or LUX

Currency: HUF

Valid from: 01.01.2024

| DIMENSION*<br>for version 71/91 with armrest 400<br>and legs H100 mm | DESCRIPTION<br>ARTICLE No |                                   | VOL. | WEIGHT | LEATHER<br>USAGE | MATRIX           | TOUCH            | ANILINE          |
|--|---------------------------|-----------------------------------|------|--------|------------------|------------------|------------------|------------------|
|  | STD<br>71/91              | <b>E2301-9074-2S</b>              | 1,25 | 58     | x                | <b>1 075 350</b> | <b>1 412 025</b> | <b>1 849 200</b> |
|  | CLS<br>71/91              | <b>E2301-9074-2C</b>              | 1,25 | 58     | x                | <b>984 900</b>   | <b>1 286 400</b> | <b>1 688 400</b> |
|  | LUX<br>71/91              | <b>E2301-9074-2L</b>              | 1,25 | 58     | x                | <b>1 075 350</b> | <b>1 412 025</b> | <b>1 849 200</b> |
| <b>110x182x78/42</b>   |                           | <b>chaiselongue 91 long right</b> |      |        |                  |                  |                  |                  |
|  | STD<br>71/91              | <b>E2301-9073-2S</b>              | 1,25 | 58     | x                | <b>1 075 350</b> | <b>1 412 025</b> | <b>1 849 200</b> |
|  | CLS<br>71/91              | <b>E2301-9073-2C</b>              | 1,25 | 58     | x                | <b>984 900</b>   | <b>1 286 400</b> | <b>1 688 400</b> |
|  | LUX<br>71/91              | <b>E2301-9073-2L</b>              | 1,25 | 58     | x                | <b>1 075 350</b> | <b>1 412 025</b> | <b>1 849 200</b> |
| <b>110x155x78/42</b>   |                           | <b>chaiselongue 91 left</b>       |      |        |                  |                  |                  |                  |
|  | STD<br>71/91              | <b>E2301-9070-2S</b>              | 1,07 | 49     | x                | <b>949 725</b>   | <b>1 341 675</b> | <b>1 738 650</b> |
|  | CLS<br>71/91              | <b>E2301-9070-2C</b>              | 1,07 | 49     | x                | <b>879 375</b>   | <b>1 221 075</b> | <b>1 592 925</b> |
|  | LUX<br>71/91              | <b>E2301-9070-2L</b>              | 1,07 | 49     | x                | <b>949 725</b>   | <b>1 341 675</b> | <b>1 738 650</b> |
| <b>110x155x78/42</b>   |                           | <b>chaiselongue 91 right</b>      |      |        |                  |                  |                  |                  |
|  | STD<br>71/91              | <b>E2301-9071-2S</b>              | 1,07 | 49     | x                | <b>949 725</b>   | <b>1 341 675</b> | <b>1 738 650</b> |
|  | CLS<br>71/91              | <b>E2301-9071-2C</b>              | 1,07 | 49     | x                | <b>879 375</b>   | <b>1 221 075</b> | <b>1 592 925</b> |
|  | LUX<br>71/91              | <b>E2301-9071-2L</b>              | 1,07 | 49     | x                | <b>949 725</b>   | <b>1 341 675</b> | <b>1 738 650</b> |
| <b>90x155x78/42</b>  |                           | <b>chaiselongue 71 left</b>       |      |        |                  |                  |                  |                  |

# QUATTRO LEATHER



**SITS**  
— comfortable life

home&family

design: SITS

## Sales Pricelist 2025

UPHOLSTERY: leather: FC - fix cover, 71/91 - loose seat cushions  
COMFORT: STD - standard, CLS - classic or LUX

Currency: HUF

Valid from: 01.01.2024

| DIMENSION*<br>for version 71/91 with armrest 400<br>and legs H100 mm | DESCRIPTION<br>ARTICLE No | VOL.                 | WEIGHT | LEATHER<br>USAGE | MATRIX | TOUCH          | ANILINE          |                  |
|--|---------------------------|----------------------|--------|------------------|--------|----------------|------------------|------------------|
|  | STD<br>71/91              | <b>E2301-7017-2S</b> | 0,91   | 44               | x      | <b>859 275</b> | <b>1 211 025</b> | <b>1 582 875</b> |
|  | CLS<br>71/91              | <b>E2301-7017-2C</b> | 0,91   | 44               | x      | <b>778 875</b> | <b>1 120 575</b> | <b>1 457 250</b> |
|  | LUX<br>71/91              | <b>E2301-7017-2L</b> | 0,91   | 44               | x      | <b>859 275</b> | <b>1 211 025</b> | <b>1 582 875</b> |

| 90x155x78/42 | chaiselongue 71 right |                      |      |    |   |                |                  |                  |
|--------------|-----------------------|----------------------|------|----|---|----------------|------------------|------------------|
|              | STD<br>71/91          | <b>E2301-7026-2S</b> | 0,91 | 44 | x | <b>859 275</b> | <b>1 211 025</b> | <b>1 582 875</b> |
|              | CLS<br>71/91          | <b>E2301-7026-2C</b> | 0,91 | 44 | x | <b>778 875</b> | <b>1 120 575</b> | <b>1 457 250</b> |
|              | LUX<br>71/91          | <b>E2301-7026-2L</b> | 0,91 | 44 | x | <b>859 275</b> | <b>1 211 025</b> | <b>1 582 875</b> |

| 144x102x78/42 | bench 91 left |                      |      |    |   |                |                  |                  |
|---------------|---------------|----------------------|------|----|---|----------------|------------------|------------------|
|               | STD<br>71/91  | <b>E2301-9047-2S</b> | 1,43 | 36 | x | <b>854 250</b> | <b>1 120 575</b> | <b>1 467 300</b> |
|               | CLS<br>71/91  | <b>E2301-9047-2C</b> | 1,43 | 36 | x | <b>778 875</b> | <b>1 025 100</b> | <b>1 346 700</b> |
|               | LUX<br>71/91  | <b>E2301-9047-2L</b> | 1,43 | 36 | x | <b>854 250</b> | <b>1 120 575</b> | <b>1 467 300</b> |

| 144x102x78/42 | bench 91 right |                      |      |    |   |                |                  |                  |
|---------------|----------------|----------------------|------|----|---|----------------|------------------|------------------|
|               | STD<br>71/91   | <b>E2301-9028-2S</b> | 1,43 | 36 | x | <b>854 250</b> | <b>1 120 575</b> | <b>1 467 300</b> |
|               | CLS<br>71/91   | <b>E2301-9028-2C</b> | 1,43 | 36 | x | <b>778 875</b> | <b>1 025 100</b> | <b>1 346 700</b> |
|               | LUX<br>71/91   | <b>E2301-9028-2L</b> | 1,43 | 36 | x | <b>854 250</b> | <b>1 120 575</b> | <b>1 467 300</b> |

| 144x102x78/42 | bench 71 left |                      |      |    |   |                |                  |                  |
|---------------|---------------|----------------------|------|----|---|----------------|------------------|------------------|
|               | STD<br>71/91  | <b>E2301-7047-2S</b> | 1,43 | 36 | x | <b>809 025</b> | <b>1 065 300</b> | <b>1 401 975</b> |

# QUATTRO LEATHER



**SITS**  
— comfortable life

home&family

design: SITS

## Sales Pricelist 2025

UPHOLSTERY: leather: FC - fix cover, 71/91 - loose seat cushions  
COMFORT: STD - standard, CLS - classic or LUX

Currency: HUF

Valid from: 01.01.2024

| DIMENSION*<br>for version 71/91 with armrest 400<br>and legs H100 mm | DESCRIPTION<br>ARTICLE No            | VOL.                     | WEIGHT | LEATHER<br>USAGE | MATRIX         | TOUCH            | ANILINE          |  |
|--|--------------------------------------|--------------------------|--------|------------------|----------------|------------------|------------------|--|
|  | CLS<br>71/91<br><b>E2301-7047-2C</b> | 1,43                     | 36     | x                | <b>753 750</b> | <b>974 850</b>   | <b>1 281 375</b> |  |
|  | LUX<br>71/91<br><b>E2301-7047-2L</b> | 1,43                     | 36     | x                | <b>809 025</b> | <b>1 065 300</b> | <b>1 401 975</b> |  |
| <b>144x102x78/42</b>   |                                      | <b>bench 71 right</b>    |        |                  |                |                  |                  |  |
|  | STD<br>71/91<br><b>E2301-7028-2S</b> | 1,43                     | 36     | x                | <b>809 025</b> | <b>1 065 300</b> | <b>1 401 975</b> |  |
|  | CLS<br>71/91<br><b>E2301-7028-2C</b> | 1,43                     | 36     | x                | <b>753 750</b> | <b>974 850</b>   | <b>1 281 375</b> |  |
|  | LUX<br>71/91<br><b>E2301-7028-2L</b> | 1,43                     | 36     | x                | <b>809 025</b> | <b>1 065 300</b> | <b>1 401 975</b> |  |
| <b>120x120x78/42</b>   |                                      | <b>corner 90° No.310</b> |        |                  |                |                  |                  |  |
|  | STD<br>71/91<br><b>E2301-9036-2S</b> | 0,95                     | 31     | x                | <b>844 200</b> | <b>1 206 000</b> | <b>1 562 775</b> |  |
|  | CLS<br>71/91<br><b>E2301-9036-2C</b> | 0,95                     | 31     | x                | <b>773 850</b> | <b>1 105 500</b> | <b>1 422 075</b> |  |
|  | LUX<br>71/91<br><b>E2301-9036-2L</b> | 0,95                     | 31     | x                | <b>844 200</b> | <b>1 206 000</b> | <b>1 562 775</b> |  |
| <b>100x100x78/42</b>   |                                      | <b>corner 90° No.320</b> |        |                  |                |                  |                  |  |
|  | STD<br>71/91<br><b>E2301-9076-2S</b> | 0,94                     | 40     | x                | <b>834 150</b> | <b>1 145 700</b> | <b>1 497 450</b> |  |
|  | CLS<br>71/91<br><b>E2301-9076-2C</b> | 0,94                     | 40     | x                | <b>768 825</b> | <b>1 050 225</b> | <b>1 371 825</b> |  |
|  | LUX<br>71/91<br><b>E2301-9076-2L</b> | 0,94                     | 40     | x                | <b>834 150</b> | <b>1 145 700</b> | <b>1 497 450</b> |  |
| <b>100x20x47</b>   |                                      | <b>armrest left</b>      |        |                  |                |                  |                  |  |
|  | STD<br>71/91<br><b>E2300-1920-2</b>  | 0,22                     | 13     | x                | <b>241 200</b> | <b>271 350</b>   | <b>326 625</b>   |  |
|  | CLS<br>71/91<br><b>E2300-1920-2</b>  | 0,22                     | 13     | x                | <b>211 050</b> | <b>236 175</b>   | <b>286 425</b>   |  |
|  | LUX<br>71/91<br><b>E2300-1920-2</b>  | 0,22                     | 13     | x                | <b>241 200</b> | <b>271 350</b>   | <b>326 625</b>   |  |
| <b>100x20x47</b>   |                                      | <b>armrest right</b>     |        |                  |                |                  |                  |  |
|  | STD<br>71/91<br><b>E2300-1910-2</b>  | 0,22                     | 13     | x                | <b>241 200</b> | <b>271 350</b>   | <b>326 625</b>   |  |
|  | CLS<br>71/91<br><b>E2300-1910-2</b>  | 0,22                     | 13     | x                | <b>211 050</b> | <b>236 175</b>   | <b>286 425</b>   |  |

QUATTRO  
LEATHER



**SITS**  
— comfortable life

home&family

design: SITS

### Sales Pricelist 2025

UPHOLSTERY: leather: FC - fix cover, 71/91 - loose seat cushions  
COMFORT: STD - standard, CLS - classic or LUX

Currency: HUF

Valid from: 01.01.2024

| DIMENSION*<br>for version 71/91 with armrest 400<br>and legs H100 mm              | DESCRIPTION<br>ARTICLE No           | VOL. | WEIGHT | LEATHER<br>USAGE | MATRIX         | TOUCH          | ANILINE        |
|---|-------------------------------------|------|--------|------------------|----------------|----------------|----------------|
|  | LUX<br>71/91<br><b>E2300-1910-2</b> | 0,22 | 13     | x                | <b>241 200</b> | <b>271 350</b> | <b>326 625</b> |

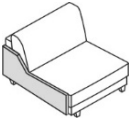
| 98x55x2,5   | endpart left |                     |      |   |   |                |                |                |
|---|--------------|---------------------|------|---|---|----------------|----------------|----------------|
|  | STD<br>71/91 | <b>E2301-1960-2</b> | 0,10 | 4 | x | <b>170 850</b> | <b>180 900</b> | <b>206 025</b> |
|   | CLS<br>71/91 | <b>E2301-1960-2</b> | 0,10 | 4 | x | <b>145 725</b> | <b>165 825</b> | <b>185 925</b> |
|   | LUX<br>71/91 | <b>E2301-1960-2</b> | 0,10 | 4 | x | <b>170 850</b> | <b>180 900</b> | <b>206 025</b> |

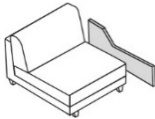
| 98x55x2,5  | endpart right |                     |      |   |   |                |                |                |
|--|---------------|---------------------|------|---|---|----------------|----------------|----------------|
|  | STD<br>71/91  | <b>E2301-1950-2</b> | 0,10 | 4 | x | <b>170 850</b> | <b>180 900</b> | <b>206 025</b> |
|  | CLS<br>71/91  | <b>E2301-1950-2</b> | 0,10 | 4 | x | <b>145 725</b> | <b>165 825</b> | <b>185 925</b> |
|  | LUX<br>71/91  | <b>E2301-1950-2</b> | 0,10 | 4 | x | <b>170 850</b> | <b>180 900</b> | <b>206 025</b> |

#### suggested sets:

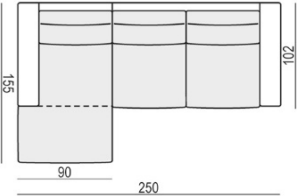
| 250/155x102x78/42   | SET 1 left - 2 seater 71 r. + chaiselongue 71 l. |                      |      |    |      |                  |                  |                  |
|---|--|----------------------|------|----|------|------------------|------------------|------------------|
|  | STD<br>71/91                                     | <b>E2301-5202-2S</b> | 2,10 | 91 | 15,1 | <b>1 834 125</b> | <b>2 628 075</b> | <b>3 457 200</b> |
|   | CLS<br>71/91                                     | <b>E2301-5202-2C</b> | 2,10 | 91 | 15,1 | <b>1 678 350</b> | <b>2 396 925</b> | <b>3 160 725</b> |
|   | LUX<br>71/91                                     | <b>E2301-5202-2L</b> | 2,10 | 91 | 15,1 | <b>1 834 125</b> | <b>2 628 075</b> | <b>3 457 200</b> |

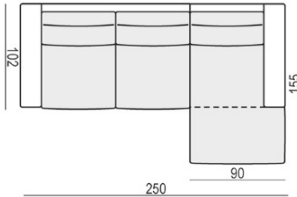
| 250/155x102x78/42   | SET 1 right - 2 seater 71 l. + chaiselongue 71 r. |                      |      |    |      |                  |                  |                  |
|---|---|----------------------|------|----|------|------------------|------------------|------------------|
|  | STD<br>71/91                                      | <b>E2301-5201-2S</b> | 2,10 | 91 | 15,1 | <b>1 834 125</b> | <b>2 628 075</b> | <b>3 457 200</b> |
|   | CLS<br>71/91                                      | <b>E2301-5201-2C</b> | 2,10 | 91 | 15,1 | <b>1 678 350</b> | <b>2 396 925</b> | <b>3 160 725</b> |
|   | LUX<br>71/91                                      | <b>E2301-5201-2L</b> | 2,10 | 91 | 15,1 | <b>1 834 125</b> | <b>2 628 075</b> | <b>3 457 200</b> |

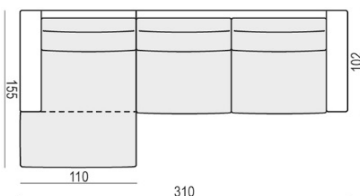
| 310/155x102x78/42   | SET 2 left - 3 seater 91 r. + chaiselongue 91 l. |                      |      |     |      |                  |                  |                  |
|---|--|----------------------|------|-----|------|------------------|------------------|------------------|
|  | STD<br>71/91                                     | <b>E2301-5402-2S</b> | 2,46 | 106 | 15,3 | <b>2 090 400</b> | <b>3 015 000</b> | <b>3 969 750</b> |
|   | CLS<br>71/91                                     | <b>E2301-5402-2C</b> | 2,46 | 106 | 15,3 | <b>1 919 550</b> | <b>2 753 700</b> | <b>3 628 050</b> |
|   | LUX<br>71/91                                     | <b>E2301-5402-2L</b> | 2,46 | 106 | 15,3 | <b>2 090 400</b> | <b>3 015 000</b> | <b>3 969 750</b> |

| 310/155x102x78/42 | SET 2 right - 3 seater 91 l. + chaiselongue 91 r. |  |  |  |  |  |  |  |
|-------------------|---|--|--|--|--|--|--|--|
|-------------------|---|--|--|--|--|--|--|--|

QUATTRO  
LEATHER



**SITS**  
— comfortable life

home&family

design: SITS

### Sales Pricelist 2025

UPHOLSTERY: leather: FC - fix cover, 71/91 - loose seat cushions  
COMFORT: STD - standard, CLS - classic or LUX

Currency: HUF

Valid from: 01.01.2024

| DIMENSION*<br>for version 71/91 with armrest 400<br>and legs H100 mm | DESCRIPTION<br>ARTICLE No | VOL.                 | WEIGHT | LEATHER<br>USAGE | MATRIX | TOUCH            | ANILINE          |                  |
|--|---------------------------|----------------------|--------|------------------|--------|------------------|------------------|------------------|
|  | STD<br>71/91              | <b>E2301-5401-2S</b> | 2,46   | 106              | 15,3   | <b>2 090 400</b> | <b>3 015 000</b> | <b>3 969 750</b> |
|  | CLS<br>71/91              | <b>E2301-5401-2C</b> | 2,46   | 106              | 15,3   | <b>1 919 550</b> | <b>2 753 700</b> | <b>3 628 050</b> |
|  | LUX<br>71/91              | <b>E2301-5401-2L</b> | 2,46   | 106              | 15,3   | <b>2 090 400</b> | <b>3 015 000</b> | <b>3 969 750</b> |

| 300/244x102x78/42 | SET 14 left - 3 seater 91 r. + corner No.320 + bench 71 l. |                      |      |     |      |                  |                  |                  |
|-------------------|--|----------------------|------|-----|------|------------------|------------------|------------------|
|                   | STD<br>71/91   | <b>E2301-5459-2S</b> | 3,00 | 151 | 22,9 | <b>2 763 750</b> | <b>3 743 625</b> | <b>4 934 550</b> |
|                   | CLS<br>71/91   | <b>E2301-5459-2C</b> | 3,00 | 151 | 22,9 | <b>2 522 550</b> | <b>3 422 025</b> | <b>4 507 425</b> |
|                   | LUX<br>71/91   | <b>E2301-5459-2L</b> | 3,00 | 151 | 22,9 | <b>2 763 750</b> | <b>3 743 625</b> | <b>4 934 550</b> |

| 300/244x102x78/42 | SET 14 right - 3 seater 91 l. + corner No.320 + bench 71 r. |                      |      |     |      |                  |                  |                  |
|-------------------|---|----------------------|------|-----|------|------------------|------------------|------------------|
|                   | STD<br>71/91  | <b>E2301-5458-2S</b> | 3,00 | 151 | 20,1 | <b>2 763 750</b> | <b>3 743 625</b> | <b>4 934 550</b> |
|                   | CLS<br>71/91  | <b>E2301-5458-2C</b> | 3,00 | 151 | 20,1 | <b>2 522 550</b> | <b>3 422 025</b> | <b>4 507 425</b> |
|                   | LUX<br>71/91  | <b>E2301-5458-2L</b> | 3,00 | 151 | 20,1 | <b>2 763 750</b> | <b>3 743 625</b> | <b>4 934 550</b> |

| 310/182x102x78/42 | SET 16 left - 3 seater 91 r. + chaiselongue 91 long l. |                      |      |     |      |                  |                  |                  |
|-------------------|--|----------------------|------|-----|------|------------------|------------------|------------------|
|                   | STD<br>71/91   | <b>E2301-5404-2S</b> | 2,89 | 116 | 15,8 | <b>2 211 000</b> | <b>3 050 175</b> | <b>4 030 050</b> |
|                   | CLS<br>71/91   | <b>E2301-5404-2C</b> | 2,89 | 116 | 15,8 | <b>2 030 100</b> | <b>2 788 875</b> | <b>3 678 300</b> |
|                   | LUX<br>71/91   | <b>E2301-5404-2L</b> | 2,89 | 116 | 15,8 | <b>2 211 000</b> | <b>3 050 175</b> | <b>4 030 050</b> |

| 310/182x102x78/42 | SET 16 right - 3 seater 91 l. + chaiselongue 91 long r. |                      |      |     |      |                  |                  |                  |
|-------------------|---|----------------------|------|-----|------|------------------|------------------|------------------|
|                   | STD<br>71/91  | <b>E2301-5403-2S</b> | 2,89 | 116 | 15,8 | <b>2 211 000</b> | <b>3 050 175</b> | <b>4 030 050</b> |
|                   | CLS<br>71/91  | <b>E2301-5403-2C</b> | 2,89 | 116 | 15,8 | <b>2 030 100</b> | <b>2 788 875</b> | <b>3 678 300</b> |

QUATTRO  
LEATHER



**SITS**  
— comfortable life

home&family

design: SITS

**Sales Pricelist 2025**

UPHOLSTERY: leather: FC - fix cover, 71/91 - loose seat cushions  
COMFORT: STD - standard, CLS - classic or LUX

Currency: HUF

Valid from: 01.01.2024

| DIMENSION*<br>for version 71/91 with armrest 400<br>and legs H100 mm | DESCRIPTION<br>ARTICLE No |                      | VOL. | WEIGHT | LEATHER<br>USAGE | MATRIX           | TOUCH            | ANILINE          |
|--|---------------------------|----------------------|------|--------|------------------|------------------|------------------|------------------|
|  | LUX<br>71/91              | <b>E2301-5403-2L</b> | 2,89 | 116    | 15,8             | <b>2 211 000</b> | <b>3 050 175</b> | <b>4 030 050</b> |

\*Explicit +/- 2 cm tolerance of all elements sizes