



design: Böttcher&Kayser

TECHNICAL SPECIFICATION

PROFILE

COMFORT: standard

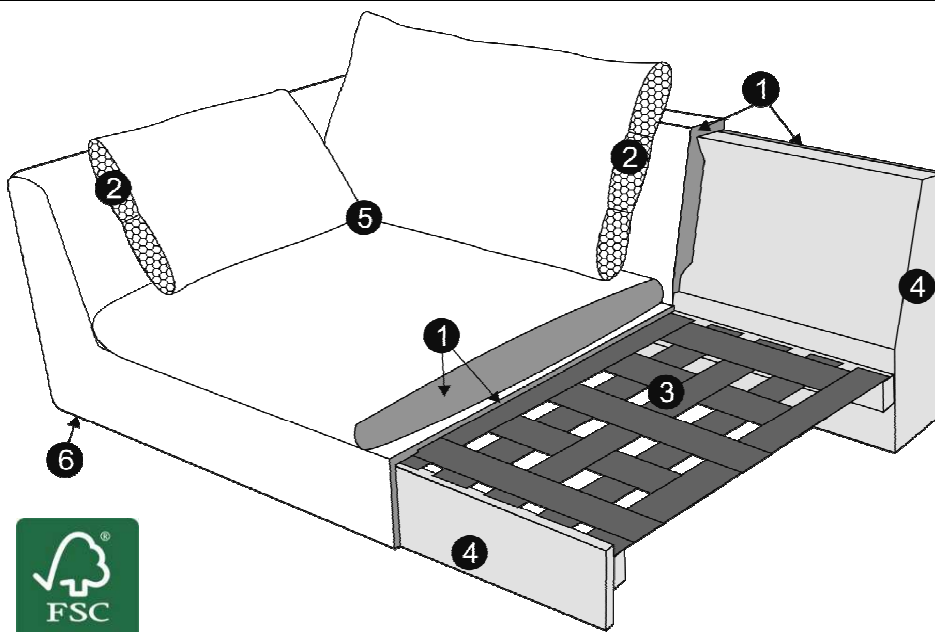

- | | |
|---|---|
| 1 | Reversible seat cushions: memory foam layer on the top / high resilient polyurethane foam at the bottom |
| 2 | silicone balls |
| 3 | upholstery belts |
| 4 | FSC® certified solid wood and wood based elements |
| 5 | fabric |
| 6 | FSC® certified solid wood legs, |

The producer reserves the right to change construction of products and components used due to improving durability of product and customer satisfaction without any further notice.

COLOURS OF VENEER TRAY



veneer: oak



veneer: walnut



veneer: black

UPHOLSTERY:

fabric: FC - fix cover COMFORT: STD - standard

FEET

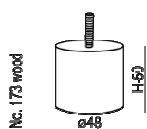



Sales Pricelist 2025

UPHOLSTERY: fabric: FC - fix cover COMFORT: STD - standard

Currency: HUF

Valid from: 01.01.2024

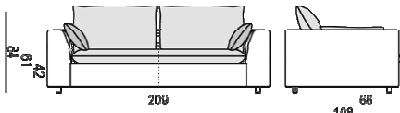
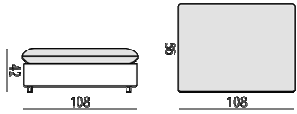
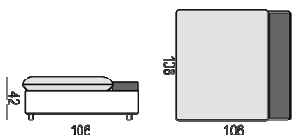
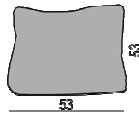
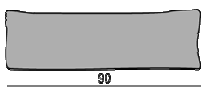
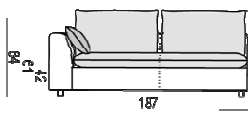
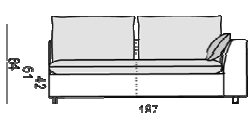
DIMENSION*	DESCRIPTION ARTICLE No	VOL.	WEIGHT	FABRIC USAGE	I	II	III	IV	E	
209x108x84/42	3 seater									
	STD	E1615-0400-2S	1,42	69	11,2	643 200	718 575	793 950	859 275	1 074 094
108x86/42	footstool 108x86									
	STD	E1615-1061-2S	0,40	29	3,4	266 325	291 450	311 550	331 650	414 563
108x106/42	footstool 108x106 with tray									
	STD	E1615-1060-2S	0,50	37	4,4	311 550	341 700	366 825	391 950	489 938
accessoires										
53x53	cushion 53x53									
	STD	E1615-5353-4P	0,05	2	0,7	30 150	30 150	35 175	40 200	50 250
90x32	cushion 90x32									
	STD	E1615-9032-4P	0,05	2	1,1	40 200	45 225	55 275	60 300	75 375
freestanding elements for building sets										
187x108x84/42	3 seater left									
	STD	E1615-0420-2S	1,80	63	9,4	572 850	638 175	698 475	753 750	942 188
187x108x84/42	3 seater right									
	STD	E1615-0410-2S	1,80	63	9,4	572 850	638 175	698 475	753 750	942 188
165x108x84/42	3 seater without armrest									



design: Böttcher&Kayser

Sales Pricelist 2025

UPHOLSTERY: fabric: FC - fix cover COMFORT: STD - standard

Currency: HUF

Valid from: 01.01.2024

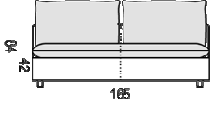
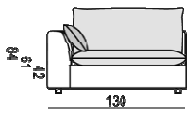
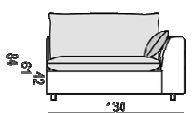
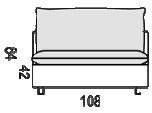
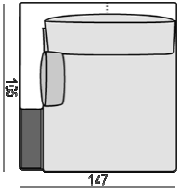
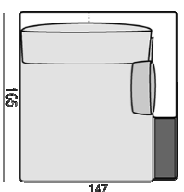
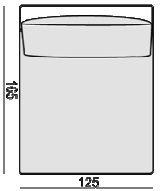
DIMENSION*	DESCRIPTION ARTICLE No	VOL.	WEIGHT	FABRIC USAGE	I	II	III	IV	E
	STD E1615-0430-2S	1,16	55	7,9	502 500	557 775	608 025	658 275	822 844
130x108x84/42	element 130x108 left								
	STD E1615-0220-2S	0,79	49	6,9	437 175	487 425	532 650	567 825	709 781
130x108x84/42	element 130x108 right								
	STD E1615-0210-2S	0,79	49	6,9	437 175	487 425	532 650	567 825	709 781
108x108x84/42	element 108x108 without armrest								
	STD E1615-0130-2S	0,75	42	5,6	376 875	412 050	452 250	482 400	603 000
147x165x84/42	chaiselongue left with tray								
	STD E1615-1200-2S	0,89	62	9,0	628 125	688 425	748 725	798 975	998 719
147x165x84/42	chaiselongue right with tray								
	STD E1615-1210-2S	0,89	62	9,0	628 125	688 425	748 725	798 975	998 719
125x165x84/42	chaiselongue without armrest								
	STD E1615-1218-2S	1,31	60	7,6	552 750	603 000	653 250	693 450	866 813



Sales Pricelist 2025

UPHOLSTERY: fabric: FC - fix cover COMFORT: STD - standard

Currency: HUF

Valid from: 01.01.2024

DIMENSION*	DESCRIPTION ARTICLE No	VOL.	WEIGHT	FABRIC USAGE	I	II	III	IV	E
106x106x84/42	corner 90°								
	STD E1615-1302-2S	0,75	46	6,3	407 025	452 250	492 450	527 625	659 531
suggested sets:									
334/165x108x84/42	SET 1 left - 3 seater r. + chaiselongue l. with tray								
	STD E1615-5402-2S	2,69	125	18,4	1 200 975	1 326 600	1 447 200	1 552 725	1 940 906
334/165x108x84/42	SET 1 right - 3 seater l. + chaiselongue r. with tray								
	STD E1615-5401-2S	2,69	125	18,4	1 200 975	1 326 600	1 447 200	1 552 725	1 940 906
396/165x108x84/42	SET 2 left - chaiselongue no armrests + 3 seater no armrest + footstool 108x106 with tray								
	STD E1615-5518-2S	2,71	152	19,9	1 366 800	1 502 475	1 628 100	1 743 675	2 179 594
396/165x108x84/42	SET 2 right - footstool 108x106 with tray + 3 seater no armrest + chaiselongue no armrests								
	STD E1615-5519-2S	2,97	152	19,9	1 366 800	1 502 475	1 628 100	1 743 675	2 179 594
398/165x108x84/42	SET 3 left - chaiselongue l. with tray + 3 seater no armrest + footstool 108x86								
	STD E1615-5521-2S	2,45	146	20,4	1 396 950	1 537 650	1 668 300	1 788 900	2 236 125

MILOU



SITS

design: Böttcher&Kayser

Sales Pricelist 2025

UPHOLSTERY: fabric: FC - fix cover COMFORT: STD - standard

Currency: HUF

Valid from: 01.01.2024

DIMENSION*	DESCRIPTION ARTICLE No	VOL.	WEIGHT	FABRIC USAGE	I	II	III	IV	E	
398/165x108x84/42	SET 3 right - footstool 108x86 + 3 seater no armrest + chaiselongue r. with tray									
	STD	E1615-5520-2S	2,45	146	20,4	1 396 950	1 537 650	1 668 300	1 788 900	2 236 125

*Explicit +/- 2 cm tolerance of all elements sizes

Załączone ceny rekomendowane mają charakter sugerowanych cen sprzedaży. Kupujący nie jest związany cenami rekomendowanymi.