

# IMPULSE

standard



**SITS**

design: SITS

## TECHNICAL SPECIFICATION

### PROFILE

COMFORT: STD - standard

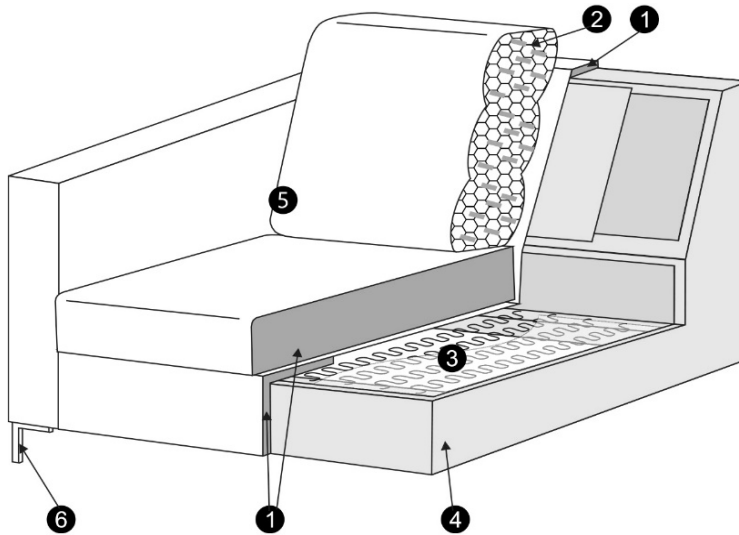

1	polyurethane foam/ high resilient polyurethane foam
2	foam flakes with silicone balls
3	springs
4	FSC® certified solid wood and wood based elements
5	fabric
6	metal legs (black or chrom) or FSC® certified solid wood legs

The producer reserves the right to change construction of products and compnents used due to improving durability of product and customer satisfaction without any further notice.

### UPHOLSTERY:

fabric: FC - fix cover, LC - loose cover or LCV - loose cover with velcro, leather: FC - fix cover  
COMFORT: STD - standard, PLUS - standard plus, CLS - classic or LUX

### ARMRESTS

**ARMREST I**  
cm 88 x 8 x 49 H

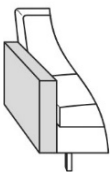

**ARMREST II**  
cm 88 x 15 x 49 H

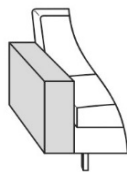

**ENDPART LEFT (or RIGHT)**  
cm 88 x 2,5 x 49 H

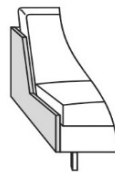

### TWO OPTIONS TO PLACE THE FEET

under armrest



under frame



### FEET

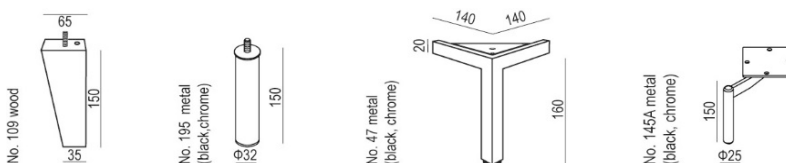

### COLOURS OF WOODEN FEET

IMPULSE  
standard



**SITS**

design: SITS

**TECHNICAL SPECIFICATION**

oak



bleached  
oak



walnut



black



IMPULSE  
standard



SITS

design: SITS

## Sales Pricelist 2025

UPHOLSTERY: fabric: FC - fix cover or LC - loose cover or LCV - loose cover with velcro  
COMFORT: STD - standard

Currency: HUF

Valid from: 01.01.2024

DIMENSION * with armrest No I and legs H-150 mm	DESCRIPTION ARTICLE No	VOL	WEIGHT	FABRIC USAGE	I	II	III	IV	E	
236x92x82/44	<b>4 seater (two parts)</b>									
	FC	<b>E1758-0900-2S</b>	1,35	94	9,8	<b>698 475</b>	<b>753 750</b>	<b>819 075</b>	<b>889 425</b>	<b>1 110 525</b>
	LC	<b>E1758-0900-6S</b>	1,35	94	9,8	<b>768 825</b>	<b>834 150</b>	<b>904 500</b>	<b>979 875</b>	<b>1 231 125</b>
	COVER	<b>E0758-0900-6</b>	0,04	6	9,8	<b>281 400</b>	<b>306 525</b>	<b>331 650</b>	<b>356 775</b>	<b>447 225</b>
	LCV	<b>E1758-0900-4S</b>	1,35	94	9,8	<b>788 925</b>	<b>854 250</b>	<b>924 600</b>	<b>1 050 225</b>	<b>1 256 250</b>
	COVER velcro	<b>E0758-0900-4</b>	0,04	6	9,8	<b>296 475</b>	<b>316 575</b>	<b>346 725</b>	<b>371 850</b>	<b>462 300</b>
218x92x82/44	<b>3 seater</b>									
	FC	<b>E1758-0400-2S</b>	1,25	58	9,2	<b>587 925</b>	<b>653 250</b>	<b>728 625</b>	<b>793 950</b>	<b>989 925</b>
	LC	<b>E1758-0400-6S</b>	1,25	58	9,2	<b>648 225</b>	<b>728 625</b>	<b>793 950</b>	<b>879 375</b>	<b>1 090 425</b>
	COVER	<b>E0758-0400-6</b>	0,04	8	9,2	<b>236 175</b>	<b>261 300</b>	<b>296 475</b>	<b>316 575</b>	<b>391 950</b>
	LCV	<b>E1758-0400-4S</b>	1,25	58	9,2	<b>658 275</b>	<b>738 675</b>	<b>814 050</b>	<b>899 475</b>	<b>1 125 600</b>
	COVER velcro	<b>E0758-0400-4</b>	0,04	8	9,2	<b>241 200</b>	<b>266 325</b>	<b>301 500</b>	<b>326 625</b>	<b>402 000</b>
196x92x82/44	<b>2,5 seater</b>									
	FC	<b>E1758-0300-2S</b>	1,14	57	8,5	<b>527 625</b>	<b>608 025</b>	<b>668 325</b>	<b>733 650</b>	<b>914 550</b>
	LC	<b>E1758-0300-6S</b>	1,14	57	8,5	<b>592 950</b>	<b>668 325</b>	<b>733 650</b>	<b>814 050</b>	<b>1 020 075</b>
	COVER	<b>E0758-0300-6</b>	0,04	5	8,5	<b>211 050</b>	<b>241 200</b>	<b>266 325</b>	<b>301 500</b>	<b>361 800</b>
	LCV	<b>E1758-0300-4S</b>	1,14	57	8,5	<b>608 025</b>	<b>683 400</b>	<b>753 750</b>	<b>839 175</b>	<b>1 035 150</b>
	COVER velcro	<b>E0758-0300-4</b>	0,04	5	8,5	<b>221 100</b>	<b>246 225</b>	<b>276 375</b>	<b>306 525</b>	<b>376 875</b>
156x92x82/44	<b>2 seater</b>									
	FC	<b>E1758-0200-2S</b>	0,90	47	7,2	<b>492 450</b>	<b>547 725</b>	<b>608 025</b>	<b>668 325</b>	<b>834 150</b>
	LC	<b>E1758-0200-6S</b>	0,90	47	7,2	<b>547 725</b>	<b>608 025</b>	<b>668 325</b>	<b>733 650</b>	<b>914 550</b>
	COVER	<b>E0758-0200-6</b>	0,02	4	7,2	<b>201 000</b>	<b>221 100</b>	<b>241 200</b>	<b>266 325</b>	<b>331 650</b>
	LCV	<b>E1758-0200-4S</b>	0,90	47	7,2	<b>552 750</b>	<b>618 075</b>	<b>683 400</b>	<b>753 750</b>	<b>934 650</b>
	COVER velcro	<b>E0758-0200-4</b>	0,02	4	7,2	<b>206 025</b>	<b>226 125</b>	<b>246 225</b>	<b>276 375</b>	<b>336 675</b>
81x92x82/44	<b>armchair</b>									
	FC	<b>E1758-0000-2S</b>	0,50	31	4,5	<b>346 725</b>	<b>371 850</b>	<b>412 050</b>	<b>457 275</b>	<b>567 825</b>
	LC	<b>E1758-0000-6S</b>	0,50	31	4,5	<b>381 900</b>	<b>412 050</b>	<b>457 275</b>	<b>502 500</b>	<b>623 100</b>
	COVER	<b>E0758-0000-6</b>	0,02	3	4,5	<b>140 700</b>	<b>165 825</b>	<b>175 875</b>	<b>190 950</b>	<b>226 125</b>

IMPULSE  
standard



SITS

design: SITS

### Sales Pricelist 2025

UPHOLSTERY: fabric: FC - fix cover or LC - loose cover or LCV - loose cover with velcro  
COMFORT: STD - standard

Currency: HUF

Valid from: 01.01.2024

DIMENSION * with armrest No I and legs H-150 mm	DESCRIPTION ARTICLE No	VOL.	WEIGHT	FABRIC USAGE	I	II	III	IV	E
	LCV E1758-0000-4S	0,50	31	4,5	391 950	417 075	467 325	507 525	643 200
	COVER velcro E0758-0000-4	0,02	3	4,5	150 750	170 850	180 900	190 950	236 175

64x80x44	footstool									
	FC E1758-1045-2S	0,20	12	1,7	201 000	221 100	226 125	246 225	311 550	
	LC E1758-1045-6S	0,20	12	1,7	221 100	241 200	261 300	281 400	346 725	
	COVER E0758-1045-6	0,01	1	1,7	85 425	90 450	95 475	100 500	130 650	
	LCV E1758-1045-4S	0,20	12	1,7	221 100	241 200	261 300	281 400	351 750	
	COVER velcro E0758-1045-4	0,01	1	1,7	85 425	90 450	95 475	105 525	130 650	

60xØ16x62	headrest 60/16 with roll (foam filling)									
	LC E1826-1660-4	0,10	3	0,7	95 475	100 500	115 575	115 575	140 700	
	COVER E0826-1660-4	0,01	1	0,7	55 275	55 275	60 300	60 300	65 325	

56x7x25	cushion									
	LC E1758-5625-4	0,01	1	0,8	80 400	80 400	85 425	95 475	115 575	
	COVER E0758-5625-4	0,01	1	0,8	50 250	50 250	50 250	55 275	60 300	

armrest protection / set of 2										
	LC E1758-1900-0	0,01	1	0,7	50 250	60 300	65 325	70 350	95 475	

#### elements for building sets:

228x92x82/44	4 seater left									
	FC E1758-0920-2S	1,31	88	9,3	618 075	683 400	738 675	793 950	994 950	
	LC E1758-0920-6S	1,31	88	9,3	688 425	748 725	814 050	879 375	1 090 425	
	COVER E0758-0920-6	0,04	6	9,3	246 225	266 325	301 500	316 575	391 950	
	LCV E1758-0920-4S	1,31	88	9,3	713 550	768 825	839 175	909 525	1 130 625	
	COVER velcro E0758-0920-4	0,04	6	9,3	251 250	276 375	306 525	326 625	402 000	

228x92x82/44	4 seater right									
	FC E1758-0910-2S	1,31	88	9,3	618 075	683 400	738 675	793 950	994 950	

IMPULSE  
standard



SITS

design: SITS

### Sales Pricelist 2025

UPHOLSTERY: fabric: FC - fix cover or LC - loose cover or LCV - loose cover with velcro  
COMFORT: STD - standard

Currency: HUF

Valid from: 01.01.2024

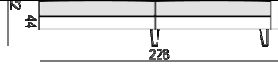
DIMENSION * with armrest No I and legs H-150 mm	DESCRIPTION ARTICLE No	VOL.	WEIGHT	FABRIC USAGE	I	II	III	IV	E	
	LC	<b>E1758-0910-6S</b>	1,31	88	9,3	<b>688 425</b>	<b>748 725</b>	<b>814 050</b>	<b>879 375</b>	<b>1 090 425</b>
	COVER	<b>E0758-0910-6</b>	0,04	6	9,3	<b>246 225</b>	<b>266 325</b>	<b>301 500</b>	<b>316 575</b>	<b>391 950</b>
	LCV	<b>E1758-0910-4S</b>	1,31	88	9,3	<b>713 550</b>	<b>768 825</b>	<b>839 175</b>	<b>909 525</b>	<b>1 130 625</b>
	COVER velcro	<b>E0758-0910-4</b>	0,04	6	9,3	<b>251 250</b>	<b>276 375</b>	<b>306 525</b>	<b>326 625</b>	<b>402 000</b>

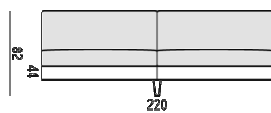
220x92x82/44	4 seater without armrests									
	FC	<b>E1758-0930-2S</b>	1,26	77	8,3	<b>547 725</b>	<b>603 000</b>	<b>648 225</b>	<b>708 525</b>	<b>879 375</b>
	LC	<b>E1758-0930-6S</b>	1,26	77	8,3	<b>608 025</b>	<b>653 250</b>	<b>713 550</b>	<b>778 875</b>	<b>974 850</b>
	COVER	<b>E0758-0930-6</b>	0,04	5	8,3	<b>221 100</b>	<b>236 175</b>	<b>251 250</b>	<b>281 400</b>	<b>351 750</b>
	LCV	<b>E1758-0930-4S</b>	1,26	77	8,3	<b>633 150</b>	<b>683 400</b>	<b>738 675</b>	<b>804 000</b>	<b>1 010 025</b>
	COVER velcro	<b>E0758-0930-4</b>	0,04	5	8,3	<b>226 125</b>	<b>241 200</b>	<b>266 325</b>	<b>296 475</b>	<b>356 775</b>

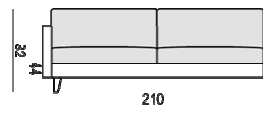
210x92x82/44	3 seater left									
	FC	<b>E1758-0420-2S</b>	1,21	53	8,3	<b>477 375</b>	<b>537 675</b>	<b>587 925</b>	<b>648 225</b>	<b>804 000</b>
	LC	<b>E1758-0420-6S</b>	1,21	53	8,3	<b>527 625</b>	<b>603 000</b>	<b>648 225</b>	<b>713 550</b>	<b>889 425</b>
	COVER	<b>E0758-0420-6</b>	0,04	5	8,3	<b>195 975</b>	<b>211 050</b>	<b>236 175</b>	<b>251 250</b>	<b>316 575</b>
	LCV	<b>E1758-0420-4S</b>	1,21	53	8,3	<b>547 725</b>	<b>618 075</b>	<b>678 375</b>	<b>738 675</b>	<b>924 600</b>
	COVER velcro	<b>E0758-0420-4</b>	0,04	5	8,3	<b>201 000</b>	<b>221 100</b>	<b>241 200</b>	<b>266 325</b>	<b>331 650</b>

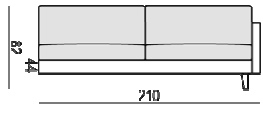
210x92x82/44	3 seater right									
	FC	<b>E1758-0410-2S</b>	1,21	53	8,3	<b>477 375</b>	<b>537 675</b>	<b>587 925</b>	<b>648 225</b>	<b>804 000</b>
	LC	<b>E1758-0410-6S</b>	1,21	53	8,3	<b>527 625</b>	<b>603 000</b>	<b>648 225</b>	<b>713 550</b>	<b>889 425</b>
	COVER	<b>E0758-0410-6</b>	0,04	5	8,3	<b>195 975</b>	<b>211 050</b>	<b>236 175</b>	<b>251 250</b>	<b>316 575</b>
	LCV	<b>E1758-0410-4S</b>	1,21	53	8,3	<b>547 725</b>	<b>618 075</b>	<b>678 375</b>	<b>738 675</b>	<b>924 600</b>
	COVER velcro	<b>E0758-0410-4</b>	0,04	5	8,3	<b>201 000</b>	<b>221 100</b>	<b>241 200</b>	<b>266 325</b>	<b>331 650</b>

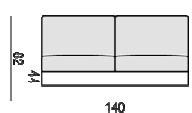
202x92x82/44	3 seater without armrests									
	FC	<b>E1758-0430-2S</b>	1,16	47	7,6	<b>417 075</b>	<b>467 325</b>	<b>507 525</b>	<b>572 850</b>	<b>708 525</b>
	LC	<b>E1758-0430-6S</b>	1,16	47	7,6	<b>462 300</b>	<b>507 525</b>	<b>572 850</b>	<b>618 075</b>	<b>778 875</b>
	COVER	<b>E0758-0430-6</b>	0,04	4	7,6	<b>175 875</b>	<b>190 950</b>	<b>206 025</b>	<b>226 125</b>	<b>281 400</b>
	LCV	<b>E1758-0430-4S</b>	1,16	47	7,6	<b>472 350</b>	<b>527 625</b>	<b>582 900</b>	<b>648 225</b>	<b>804 000</b>
	COVER velcro	<b>E0758-0430-4</b>	0,04	4	7,6	<b>180 900</b>	<b>195 975</b>	<b>211 050</b>	<b>236 175</b>	<b>296 475</b>

IMPULSE  
standard



SITS



design: SITS

## Sales Pricelist 2025

UPHOLSTERY: fabric: FC - fix cover or LC - loose cover or LCV - loose cover with velcro  
COMFORT: STD - standard

Currency: HUF

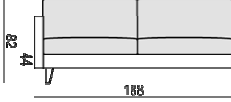
Valid from: 01.01.2024

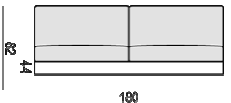
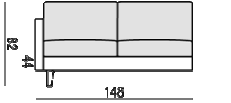
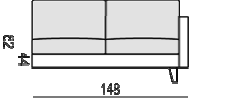
DIMENSION * with armrest No I and legs H-150 mm	DESCRIPTION ARTICLE No	VOL	WEIGHT	FABRIC USAGE	I	II	III	IV	E	
	<b>2,5 seater left</b>									
	FC	E1758-0320-2S	1,08	50	7,6	462 300	502 500	552 750	608 025	753 750
	LC	E1758-0320-6S	1,08	50	7,6	502 500	552 750	613 050	678 375	834 150
	COVER	E0758-0320-6	0,04	5	7,6	190 950	201 000	221 100	241 200	301 500
	LCV	E1758-0320-4S	1,08	50	7,6	522 600	577 875	643 200	698 475	859 275
COVER velcro	E0758-0320-4	0,04	5	7,6	195 975	206 025	226 125	246 225	311 550	
	<b>2,5 seater right</b>									
	FC	E1758-0310-2S	1,08	50	7,6	462 300	502 500	552 750	608 025	753 750
	LC	E1758-0310-6S	1,08	50	7,6	502 500	552 750	613 050	678 375	834 150
	COVER	E0758-0310-6	0,04	5	7,6	190 950	201 000	221 100	241 200	301 500
	LCV	E1758-0310-4S	1,08	50	7,6	522 600	577 875	643 200	698 475	859 275
COVER velcro	E0758-0310-4	0,04	5	7,6	195 975	206 025	226 125	246 225	311 550	
	<b>2,5 seater without armrests</b>									
	FC	E1758-0330-2S	1,04	42	6,9	371 850	432 150	467 325	507 525	643 200
	LC	E1758-0330-6S	1,04	42	6,9	417 075	467 325	507 525	572 850	708 525
	COVER	E0758-0330-6	0,04	4	6,9	165 825	180 900	190 950	206 025	251 250
	LCV	E1758-0330-4S	1,04	42	6,9	437 175	477 375	527 625	582 900	728 625
COVER velcro	E0758-0330-4	0,04	4	6,9	170 850	180 900	195 975	211 050	261 300	
	<b>2 seater left</b>									
	FC	E1758-0220-2S	0,90	39	6,3	396 975	442 200	477 375	522 600	653 250
	LC	E1758-0220-6S	0,90	39	6,3	442 200	492 450	527 625	582 900	723 600
	COVER	E0758-0220-6	0,04	4	6,3	170 850	185 925	195 975	211 050	261 300
	LCV	E1758-0220-4S	0,90	39	6,3	462 300	502 500	547 725	608 025	748 725
COVER velcro	E0758-0220-4	0,04	4	6,3	175 875	190 950	201 000	211 050	266 325	
	<b>2 seater right</b>									
	FC	E1758-0210-2S	0,90	39	6,3	396 975	442 200	477 375	522 600	653 250
	LC	E1758-0210-6S	0,90	39	6,3	442 200	492 450	527 625	582 900	723 600
COVER	E0758-0210-6	0,04	4	6,3	170 850	185 925	195 975	211 050	261 300	

IMPULSE  
standard



SITS

design: SITS

## Sales Pricelist 2025

UPHOLSTERY: fabric: FC - fix cover or LC - loose cover or LCV - loose cover with velcro  
COMFORT: STD - standard

Currency: HUF

Valid from: 01.01.2024

DIMENSION * with armrest No I and legs H-150 mm	DESCRIPTION ARTICLE No	VOL	WEIGHT	FABRIC USAGE	I	II	III	IV	E
	LCV E1758-0210-4S	0,90	39	6,3	462 300	502 500	547 725	608 025	748 725
	COVER velcro E0758-0210-4	0,04	4	6,3	175 875	190 950	201 000	211 050	266 325

140x92x82/44	2 seater without armrests									
	FC	E1758-0230-2S	0,81	37	5,5	316 575	356 775	391 950	437 175	537 675
	LC	E1758-0230-6S	0,81	37	5,5	351 750	396 975	437 175	472 350	603 000
	COVER	E0758-0230-6	0,04	4	5,5	130 650	150 750	170 850	180 900	211 050
	LCV	E1758-0230-4S	0,81	37	5,5	361 800	417 075	447 225	492 450	618 075
	COVER velcro	E0758-0230-4	0,04	4	5,5	130 650	165 825	175 875	185 925	221 100

92x185x82/44	divan left									
	FC	E1758-1230-2S	1,18	47	7,8	477 375	527 625	582 900	643 200	793 950
	LC	E1758-1230-6S	1,18	47	7,8	527 625	587 925	643 200	708 525	879 375
	COVER	E0758-1230-6	0,04	5	7,8	195 975	211 050	236 175	251 250	316 575
	LCV	E1758-1230-4S	1,18	47	7,8	547 725	613 050	658 275	728 625	909 525
	COVER velcro	E0758-1230-4	0,04	5	7,8	201 000	221 100	241 200	261 300	326 625

92x185x82/44	divan right									
	FC	E1758-1231-2S	1,18	47	7,8	477 375	527 625	582 900	643 200	793 950
	LC	E1758-1231-6S	1,18	47	7,8	527 625	587 925	643 200	708 525	879 375
	COVER	E0758-1231-6	0,04	5	7,8	195 975	211 050	236 175	251 250	316 575
	LCV	E1758-1231-4S	1,18	47	7,8	547 725	613 050	658 275	728 625	909 525
	COVER velcro	E0758-1231-4	0,04	5	7,8	201 000	221 100	241 200	261 300	326 625

92x124x82/44	bench left									
	FC	E1758-1310-2S	0,70	35	4,5	316 575	351 750	371 850	402 000	502 500
	LC	E1758-1310-6S	0,70	35	4,5	351 750	381 900	417 075	447 225	552 750
	COVER	E0758-1310-6	0,04	3	4,5	130 650	140 700	165 825	175 875	201 000
	LCV	E1758-1310-4S	0,70	35	4,5	361 800	396 975	437 175	467 325	577 875
	COVER velcro	E0758-1310-4	0,04	3	4,5	130 650	150 750	170 850	175 875	206 025

92x124x82/44	bench right									
	FC	E1758-1311-2S	0,70	35	4,5	316 575	351 750	371 850	402 000	502 500

IMPULSE  
standard



SITS

design: SITS

### Sales Pricelist 2025

UPHOLSTERY: fabric: FC - fix cover or LC - loose cover or LCV - loose cover with velcro  
COMFORT: STD - standard

Currency: HUF

Valid from: 01.01.2024

DIMENSION * with armrest No I and legs H-150 mm	DESCRIPTION ARTICLE No	VOL.	WEIGHT	FABRIC USAGE	I	II	III	IV	E
	LC E1758-1311-6S	0,70	35	4,5	351 750	381 900	417 075	447 225	552 750
	COVER E0758-1311-6	0,04	3	4,5	130 650	140 700	165 825	175 875	201 000
	LCV E1758-1311-4S	0,70	35	4,5	361 800	396 975	437 175	467 325	577 875
	COVER velcro E0758-1311-4	0,04	3	4,5	130 650	150 750	170 850	175 875	206 025

92x92x82/44	corner 90°									
	FC E1758-1302-2S	0,51	27	4,4	311 550	336 675	361 800	391 950	492 450	
	LC E1758-1302-6S	0,51	27	4,4	336 675	371 850	402 000	437 175	537 675	
	COVER E0758-1302-6	0,02	3	4,4	125 625	140 700	165 825	170 850	195 975	
	LCV E1758-1302-4S	0,51	27	4,4	356 775	391 950	432 150	447 225	552 750	
	COVER velcro E0758-1302-4	0,02	3	4,4	130 650	140 700	165 825	175 875	201 000	

88x49x2,5	endpart left									
	FC E1758-1960-2	0,02	3	1,1	85 425	90 450	100 500	105 525	130 650	

88x49x2,5	endpart right									
	FC E1758-1950-2	0,02	3	1,1	85 425	90 450	100 500	105 525	130 650	

#### suggested sets:

282/185x92x82/44	SET 4 left - 2,5 seater r. + divan l.									
	FC E1758-5308-2S	2,20	96	15,4	969 825	1 085 400	1 195 950	1 316 550	1 638 150	
	LC E1758-5308-6S	2,20	96	15,4	1 070 325	1 195 950	1 316 550	1 452 225	1 809 000	
	COVER E0758-5308-6	0,08	9	15,4	376 875	432 150	472 350	507 525	643 200	
	LCV E1758-5308-4S	2,20	96	15,4	1 085 400	1 216 050	1 341 675	1 472 325	1 839 150	
	COVER velcro E0758-5308-4	0,08	9	15,4	391 950	442 200	482 400	527 625	658 275	

282/185x92x82/44	SET 4 right - 2,5 seater l. + divan r.									
	FC E1758-5307-2S	2,20	96	15,4	969 825	1 085 400	1 195 950	1 316 550	1 638 150	



IMPULSE  
standard



SITS

design: SITS

## Sales Pricelist 2025

UPHOLSTERY: fabric: FC - fix cover or LC - loose cover or LCV - loose cover with velcro  
COMFORT: STD - standard

Currency: HUF

Valid from: 01.01.2024

DIMENSION * with armrest No I and legs H-150 mm	DESCRIPTION ARTICLE No	VOL.	WEIGHT	FABRIC USAGE	I	II	III	IV	E	
	LC	<b>E1758-5307-6S</b>	2,20	96	15,4	<b>1 070 325</b>	<b>1 195 950</b>	<b>1 316 550</b>	<b>1 452 225</b>	<b>1 809 000</b>
	COVER	<b>E0758-5307-6</b>	0,08	9	15,4	<b>376 875</b>	<b>432 150</b>	<b>472 350</b>	<b>507 525</b>	<b>643 200</b>
	LCV	<b>E1758-5307-4S</b>	2,20	96	15,4	<b>1 085 400</b>	<b>1 216 050</b>	<b>1 341 675</b>	<b>1 472 325</b>	<b>1 839 150</b>
	COVER velcro	<b>E0758-5307-4</b>	0,08	9	15,4	<b>391 950</b>	<b>442 200</b>	<b>482 400</b>	<b>527 625</b>	<b>658 275</b>

240/185x92x82/44	SET 5 left - 2 seater r. + divan l.									
	FC	<b>E1758-5208-2S</b>	1,90	88	14,0	<b>879 375</b>	<b>989 925</b>	<b>1 090 425</b>	<b>1 206 000</b>	<b>1 507 500</b>
	LC	<b>E1758-5208-6S</b>	1,90	88	14,0	<b>974 850</b>	<b>1 090 425</b>	<b>1 206 000</b>	<b>1 326 600</b>	<b>1 653 225</b>
	COVER	<b>E0758-5208-6</b>	0,08	8	14,0	<b>351 750</b>	<b>391 950</b>	<b>437 175</b>	<b>472 350</b>	<b>587 925</b>
	LCV	<b>E1758-5208-4S</b>	1,90	88	14,0	<b>989 925</b>	<b>1 110 525</b>	<b>1 221 075</b>	<b>1 351 725</b>	<b>1 683 375</b>
	COVER velcro	<b>E0758-5208-4</b>	0,08	8	14,0	<b>356 775</b>	<b>402 000</b>	<b>447 225</b>	<b>482 400</b>	<b>603 000</b>

240/185x92x82/44	SET 5 right - 2 seater l. + divan r.									
	FC	<b>E1758-5207-2S</b>	1,90	88	14,0	<b>879 375</b>	<b>989 925</b>	<b>1 090 425</b>	<b>1 206 000</b>	<b>1 507 500</b>
	LC	<b>E1758-5207-6S</b>	1,90	88	14,0	<b>974 850</b>	<b>1 090 425</b>	<b>1 206 000</b>	<b>1 326 600</b>	<b>1 653 225</b>
	COVER	<b>E0758-5207-6</b>	0,08	8	14,0	<b>351 750</b>	<b>391 950</b>	<b>437 175</b>	<b>472 350</b>	<b>587 925</b>
	LCV	<b>E1758-5207-4S</b>	1,90	88	14,0	<b>989 925</b>	<b>1 110 525</b>	<b>1 221 075</b>	<b>1 351 725</b>	<b>1 683 375</b>
	COVER velcro	<b>E0758-5207-4</b>	0,08	8	14,0	<b>356 775</b>	<b>402 000</b>	<b>447 225</b>	<b>482 400</b>	<b>603 000</b>

\*Explicit +/- 2 cm tolerance of all elements sizes

Załączone ceny rekomendowane mają charakter sugerowanych cen sprzedaży. Kupujący nie jest związany cenami rekomendowanymi.