

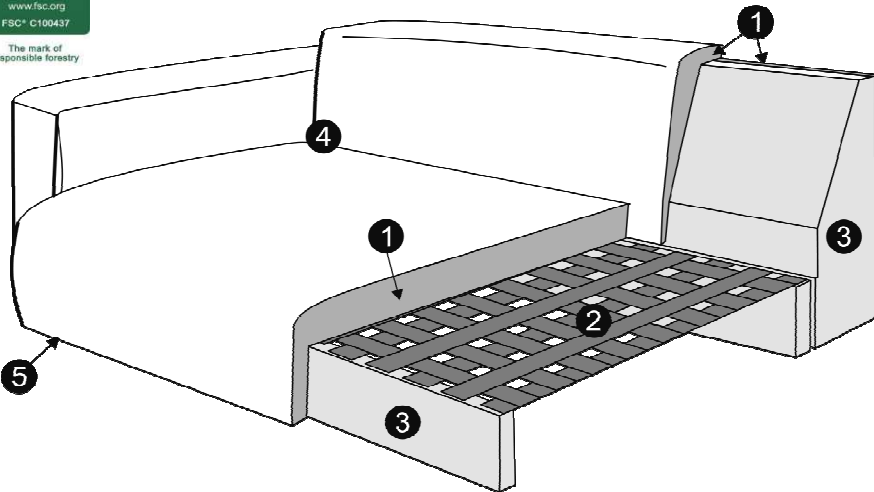

TECHNICAL SPECIFICATION

PROFILE

COMFORT: standard



1	polyurethane foam/ high resilient foam
2	upholstery belts
3	FSC® certified solid wood and wood based elements
4	fabric
5	FSC® certified solid wood legs

COMFORT: lux

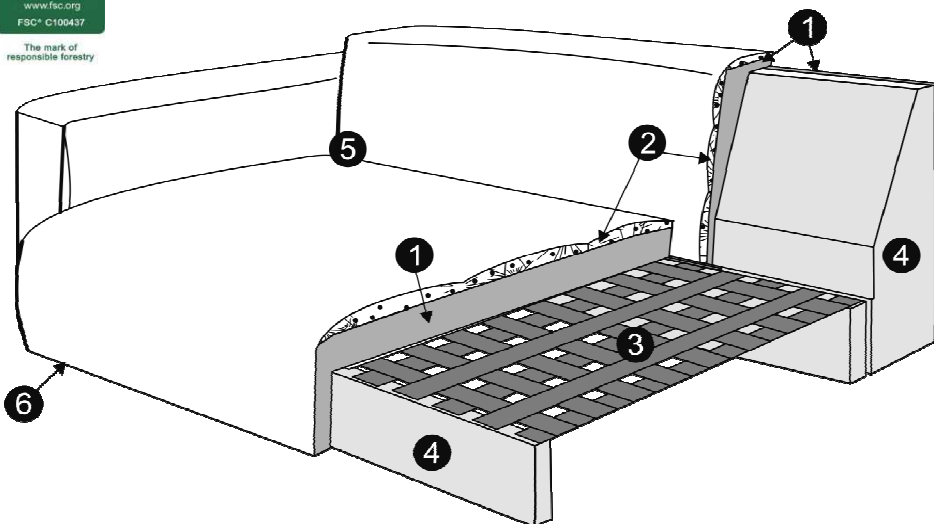

1	polyurethane foam/high resilient polyurethane foam
2	cushion chamber with mix of feather and silicone balls
3	upholstery belts
4	FSC® certified solid wood and wood based elements
5	fabric
6	FSC® certified solid wood legs

The producer reserves the right to change construction of products and compnents used due to improving durability of product and customer satisfaction without any further notice.

UPHOLSTERY:

fabric: LCV - loose cover with velcro comfort: standard

EDDA



SITS

design: Böttcher&Kayser

TECHNICAL SPECIFICATION

FEET

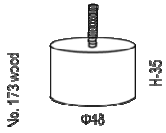

COLOURS OF WOODEN FEET



COLOURS OF VENEER TOP FOR COFFEE TABLE



wood: oak



wood: black



wood: walnut



design: Böttcher&Kayser

Sales Pricelist 2025

UPHOLSTERY: fabric: LCV - loose cover with velcro
COMFORTS: STD - standard, LUX - lux

Currency: HUF

Valid from: 01.01.2024

DIMENSION*	DESCRIPTION ARTICLE No	VOL.	WEIGHT	FABRIC USAGE	I	II	III	IV	E
------------	---------------------------	------	--------	-----------------	---	----	-----	----	---

freestanding elements for building sets

74x109x70/42	element 74									
	STD	E1587-0030-04S	0,59	27	3,3	336 675	366 825	386 925	407 025	457 275
	LUX	E1587-0030-04L	0,59	27	3,3	336 675	366 825	386 925	407 025	457 275
	COVER	E0587-0030-04	0,03	3	3,3	160 800	185 925	211 050	256 275	170 850

114x109x70/42	element 114									
	STD	E1587-0130-04S	0,90	38	4,5	417 075	457 275	487 425	512 550	577 875
	LUX	E1587-0130-04L	0,90	38	4,5	417 075	457 275	487 425	512 550	577 875
	COVER	E0587-0130-04	0,03	3	4,5	190 950	236 175	276 375	311 550	206 025

144x109x70/42	element 144									
	STD	E1587-0230-04S	1,13	46	5,5	487 425	517 575	557 775	587 925	678 375
	LUX	E1587-0230-04L	1,13	46	5,5	487 425	517 575	557 775	587 925	678 375
	COVER	E0587-0230-04	0,04	4	5,5	216 075	266 325	311 550	356 775	241 200

114x168x70/42	chaiselongue 114 /no armrests									
	STD	E1587-1218-04S	1,42	50	5,2	522 600	557 775	597 975	628 125	703 500
	LUX	E1587-1218-04L	1,42	50	5,2	522 600	557 775	597 975	628 125	703 500
	COVER	E0587-1218-04	0,04	3,7	5,2	251 250	286 425	331 650	386 925	261 300

144x168x70/42	chaiselongue 144 /no armrests									
	STD	E1587-1219-04S	1,71	64	6,3	638 175	683 400	728 625	763 800	864 300
	LUX	E1587-1219-04L	1,71	64	6,3	638 175	683 400	728 625	763 800	864 300
	COVER	E0587-1219-04	0,04	3,9	6,3	296 475	346 725	407 025	462 300	311 550

bench left	bench left									
	STD	E1587-1310-04S	1,13	47	4,8	462 300	492 450	522 600	552 750	628 125
	LUX	E1587-1310-04L	1,13	47	4,8	462 300	492 450	522 600	552 750	628 125
	COVER	E0587-1310-04	0,03	4	4,8	211 050	256 275	291 450	336 675	221 100

144x109x70/42	bench right									
	STD	E1587-1311-04S	1,13	47	4,8	462 300	492 450	522 600	552 750	628 125
	LUX	E1587-1311-04L	1,13	47	4,8	462 300	492 450	522 600	552 750	628 125





Sales Pricelist 2025

UPHOLSTERY: fabric: LCV - loose cover with velcro
COMFORTS: STD - standard, LUX - lux

Currency: HUF

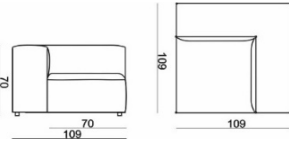
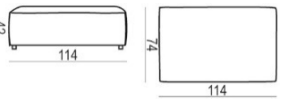
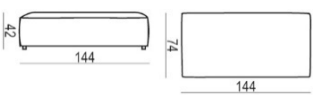
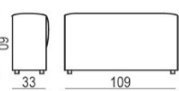
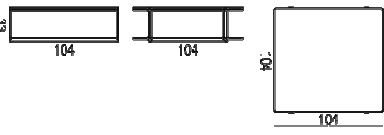
Valid from: 01.01.2024

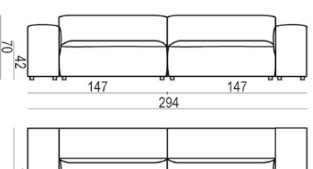
DIMENSION*	DESCRIPTION ARTICLE No	VOL.	WEIGHT	FABRIC USAGE	I	II	III	IV	E
	COVER E0587-1311-04	0,03	4	4,8	211 050	256 275	291 450	336 675	221 100
109x109x70/42	corner 90								
	STD E1587-1302-04S	0,87	44	5,5	472 350	507 525	552 750	582 900	663 300
	LUX E1587-1302-04L	0,87	44	5,5	472 350	507 525	552 750	582 900	663 300
	COVER E0587-1302-04	0,04	4	5,5	211 050	256 275	291 450	336 675	221 100
114x74x42	footstool 114								
	STD E1587-1065-04S	0,38	22	2,6	221 100	251 250	266 325	281 400	311 550
	LUX E1587-1065-04L	0,38	22	2,6	221 100	251 250	266 325	281 400	311 550
	COVER E0587-1065-04	0,02	2	2,6	105 525	135 675	155 775	175 875	110 550
144x74x42	footstool 144								
	STD E1587-1070-04S	0,44	27	3,3	276 375	296 475	316 575	336 675	391 950
	LUX E1587-1070-04L	0,44	27	3,3	276 375	296 475	316 575	336 675	391 950
	COVER E0587-1070-04	0,02	2	3,3	135 675	155 775	180 900	206 025	145 725
109x33x60	armrest right/left								
	STD E1587-1990-4S	0,26	20	2,0	236 175	251 250	266 325	276 375	301 500
	LUX E1587-1990-4L	0,26	20	2,0	236 175	251 250	266 325	276 375	301 500
	COVER E0587-1990-4	0,02	2	2,0	105 525	135 675	155 775	170 850	110 550
104x104x33	coffee table 104x104								
	STD 1587-1577	0,10	35	x	246 225	246 225	246 225	246 225	246 225
104x31x33	coffee table 104x31								
	STD 1587-1576	0,02	14	x	180 900	180 900	180 900	180 900	180 900
suggested sets:									
294x109x70/42	SET.1 - 2x element 114 + 2x armrest								
	STD E1587-5190-04S	2,32	116	10,9	1 306 500	1 417 050	1 507 500	1 577 850	1 758 750
	LUX E1587-5190-04L	2,32	116	10,9	1 306 500	1 417 050	1 507 500	1 577 850	1 758 750

EDDA



SITS

design: Böttcher&Kayser



Sales Pricelist 2025



UPHOLSTERY: fabric: LCV - loose cover with velcro
COMFORTS: STD - standard, LUX - lux

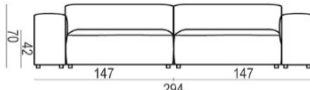

Currency: HUF

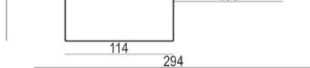
Valid from: 01.01.2024

DIMENSION*	DESCRIPTION ARTICLE No	VOL.	WEIGHT	FABRIC USAGE	I	II	III	IV	E
	COVER E0587-5190-04	0,10	10,0	10,9	592 950	743 700	864 300	964 800	1 055 250

294/168x109x70/42	SET.2 - chaiselongue 114/no armrest + element 114 + 2x armrest									
	STD	E1587-5191-04S	2,84	128	11,9	1 412 025	1 517 550	1 618 050	1 693 425	1 884 375
	LUX	E1587-5191-04L	2,84	128	11,9	1 412 025	1 517 550	1 618 050	1 693 425	1 884 375
	COVER	E0587-5191-04	0,10	10	11,9	653 250	793 950	919 575	1 040 175	1 130 625

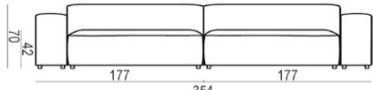
385/168x109x70/42	SET.3 - chaiselongue 144/no armrest + element 144 + 2x armrest + coffee table									
	STD	E1587-5225-04S	3,09	149	13,4	1 778 850	1 884 375	1 999 950	2 085 375	2 326 575
	LUX	E1587-5225-04L	3,09	149	13,4	1 778 850	1 884 375	1 999 950	2 085 375	2 326 575
	COVER	E0587-5225-04	0,11	10	13,4	904 500	1 065 300	1 211 025	1 341 675	1 396 950

354/168x109x70/42	SET.4 - chaiselongue 144/no armrest + element 144 + 2x armrest									
	STD	E1587-5226-04S	3,36	150	13,4	1 597 950	1 703 475	1 819 050	1 904 475	2 145 675
	LUX	E1587-5226-04L	3,36	150	13,4	1 597 950	1 703 475	1 819 050	1 904 475	2 145 675
	COVER	E0587-5226-04	0,24	12	13,4	723 600	884 400	1 030 125	1 160 775	1 291 425

*Explicit +/- 2 cm tolerance of all elements sizes

Załączone ceny rekomendowane mają charakter sugerowanych cen sprzedaży. Kupujący nie jest związany cenami rekomendowanymi.