

CLARK

fabric



SITS

design: Niels Gammelgaard

TECHNICAL SPECIFICATION

PROFILE

COMFORT: standard

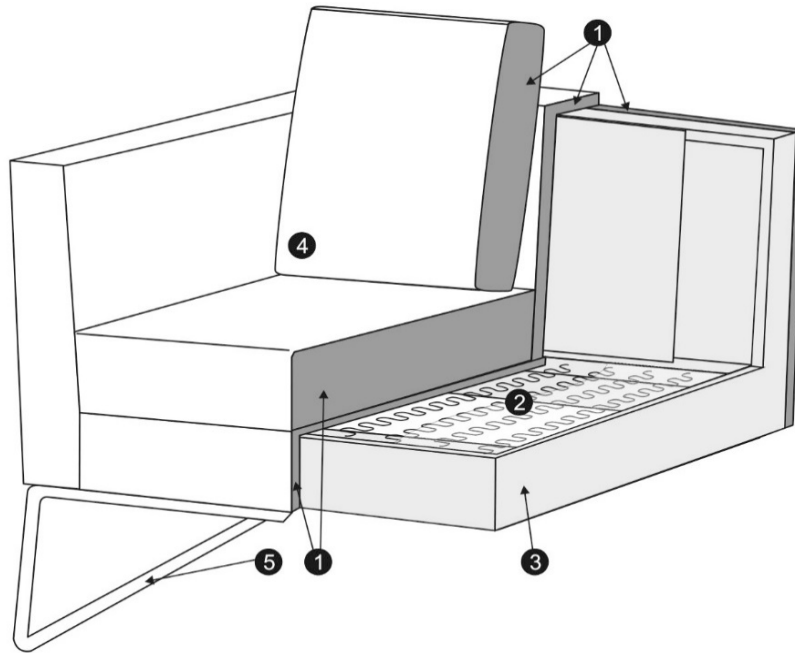

| | |
|---|---|
| 1 | polyurethane foam/ high resilient polyurethane foam |
| 2 | springs |
| 3 | solid wood and wood based elements |
| 4 | fabric |
| 5 | metal frame (black or chrome) |

The producer reserves the right to change construction of products and compnents used due to improving durability of product and customer satisfaction without any further notice.

UPHOLSTERY:

fabric or leather: FC - fix cover, COMFORT: standard

FEET

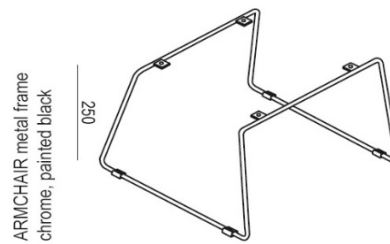
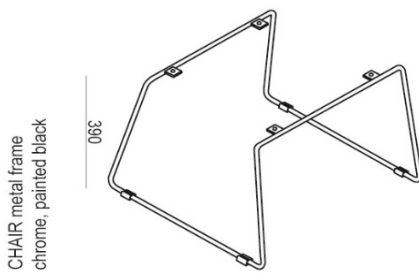

CLARK
fabric



SITS

design: Niels Gammelgaard

Sales Pricelist 2025

UPHOLSTERY: fabric: FC - fix cover COMFORT: standard

Currency: HUF

Valid from: 01.01.2024

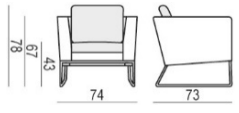
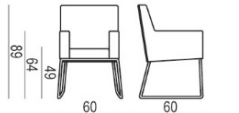
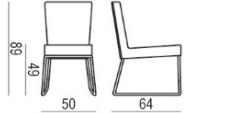
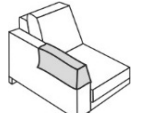
| DIMENSION* | DESCRIPTION ARTICLE No | VOL. | WEIGHT | FABRIC USAGE | I | II | III | IV | E |
|---|--|------|--------|-----------------|----------------|----------------|----------------|----------------|----------------|
| 74x73x78/43  | armchair FC E1553-0001-2S | 0,50 | 23 | 3,1 | 266 325 | 281 400 | 311 550 | 331 650 | 402 000 |
| 60x60x89/49  | chair with armrests FC E1553-1501-2S | 0,40 | 15 | 1,6 | 195 975 | 201 000 | 211 050 | 226 125 | 276 375 |
| 50x64x89/49  | chair without armrests FC E1553-1500-2S | 0,40 | 15 | 1,1 | 180 900 | 185 925 | 195 975 | 201 000 | 246 225 |
|  | armrest protection / set of 2 LC E1553-1900-0 | 0,01 | 1 | 0,7 | 50 250 | 60 300 | 65 325 | 70 350 | 95 475 |

*Explicit +/- 2 cm tolerance of all elements sizes

Załączone ceny rekomendowane mają charakter sugerowanych cen sprzedaży. Kupujący nie jest związany cenami rekomendowanymi.