

ASTA



SITS

design: Ian Archer

TECHNICAL SPECIFICATION

PROFILE

COMFORT: lux

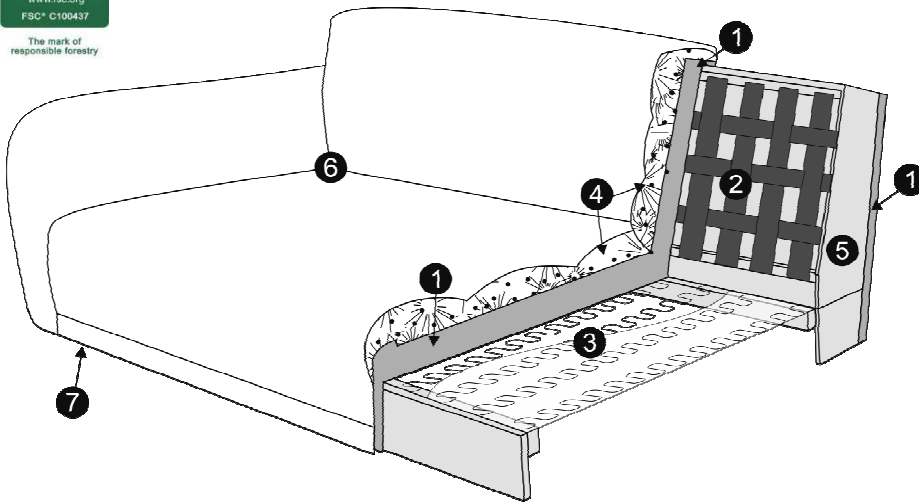

1	polyurethane foam/ high resilient polyurethane foam
2	upholstery belts
3	springs
4	cushion chamber with mix of feather and silicone balls
5	FSC® certified solid wood and wood based elements
6	fabric
7	plastic legs

COMFORT: lux - chaiselongue

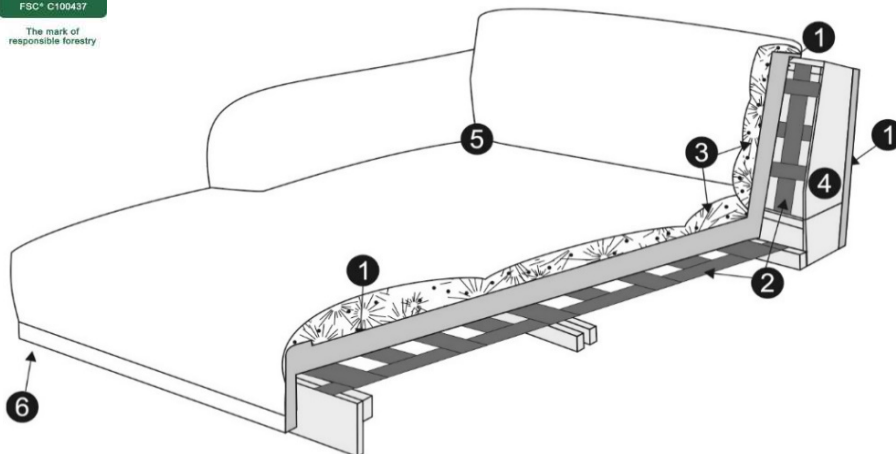

1	polyurethane foam/ high resilient polyurethane foam
2	upholstery belts
3	cushion chamber with mix of feather and silicone balls
4	FSC® certified solid wood and wood based elements
5	fabric
6	plastic legs

The producer reserves the right to change construction of products and compnents used due to improving durability of product and customer satisfaction without any further notice.

UPHOLSTERY:

fabric: FC - fix cover, Comfort: LUX

FEET

No. 37c plate



ASTA



SITS

design: Ian Archer

Sales Pricelist 2025

UPHOLSTERY: fabric: FC - fix cover COMFORT: lux

Currency: HUF

Valid from: 01.01.2024

DIMENSION*	DESCRIPTION ARTICLE No	VOL.	WEIGHT	FABRIC USAGE	I	II	III	IV	E
268x104x79/44 	4 seater divided LUX E1646-0900-2L	2,27	92	10,5	964 800	1 035 150	1 115 550	1 175 850	1 467 300
228x104x79/44 	3 seater divided LUX E1646-0500-2L	1,94	86	10,5	914 550	984 900	1 065 300	1 125 600	1 407 000
102x97/44 	footstool 102x97 LUX E1646-1060-2L	0,42	27	2,9	231 150	251 250	266 325	286 425	356 775
97x82/44 	footstool 97x82 LUX E1646-1055-2L	0,33	22	2,9	221 100	236 175	251 250	271 350	336 675
elements for building sets:									
134x104x79/44 	element 134 left LUX E1646-0220-2L	1,14	46	5,3	482 400	517 575	557 775	587 925	733 650
134x104x79/44 	element 134 right LUX E1646-0210-2L	1,14	46	5,3	482 400	517 575	557 775	587 925	733 650
114x104x79/44 	element 114 left LUX E1646-0120-2L	0,97	43	5,3	457 275	492 450	532 650	562 800	703 500
114x104x79/44 	element 114 right LUX E1646-0110-2L	0,97	43	5,3	457 275	492 450	532 650	562 800	703 500
102x104x79/44	element 102 without armrests								

ASTA



SITS

design: Ian Archer

Sales Pricelist 2025

UPHOLSTERY: fabric: FC - fix cover COMFORT: lux

Currency: HUF

Valid from: 01.01.2024

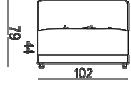
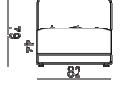
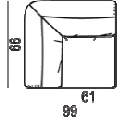
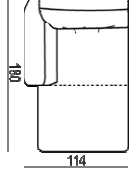
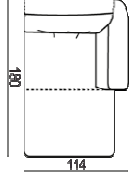
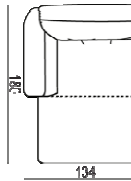
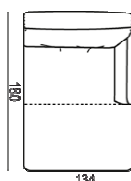
DIMENSION*	DESCRIPTION ARTICLE No	VOL.	WEIGHT	FABRIC USAGE	I	II	III	IV	E
	LUX E1646-0230-2L	0,87	34	3,8	366 825	391 950	417 075	437 175	547 725
82x104x79/44		element 82 without armrests							
	LUX E1646-0130-2L	0,70	28	3,8	326 625	356 775	386 925	407 025	502 500
99x99x79/44		corner 90°							
	LUX E1646-1302-2L	0,85	39	5,0	412 050	442 200	477 375	507 525	633 150
114x180x79/44		chaiselongue left**							
	LUX E1646-1200-2L	1,70	59	6,5	592 950	633 150	678 375	718 575	894 450
114x180x79/44		chaiselongue right**							
	LUX E1646-1210-2L	1,70	59	6,5	592 950	633 150	678 375	718 575	894 450
134x180x79/44		chaiselongue wide left**							
	LUX E1646-1201-2L	1,95	69	6,5	623 100	663 300	713 550	753 750	939 675
134x180x79/44		chaiselongue wide right**							
	LUX E1646-1211-2L	1,95	69	6,5	623 100	663 300	713 550	753 750	939 675

ASTA



SITS

design: Ian Archer

Sales Pricelist 2025

UPHOLSTERY: fabric: FC - fix cover COMFORT: lux

Currency: HUF

Valid from: 01.01.2024

DIMENSION*	DESCRIPTION ARTICLE No	VOL.	WEIGHT	FABRIC USAGE	I	II	III	IV	E
------------	---------------------------	------	--------	-----------------	---	----	-----	----	---

suggested sets:

335/233x104x79/44		SET.1 left - element 134 l. + corner 90 + element 102 + element 134 r.								
	LUX	E1646-5701-2L	3,99	165	19,4	1 608 000	1 728 600	1 859 250	1 969 800	2 457 225

335/233x104x79/44		SET.1 right - element 134 r. + corner 90 + element 102 + element 134 l.								
	LUX	E1646-5700-2L	3,99	165	19,4	1 608 000	1 728 600	1 859 250	1 969 800	2 457 225

268/180x104x79/44		SET 2 left - chaiselongue wide l.** + element 134 r.								
	LUX	E1646-5206-2L	3,08	115	11,7	1 105 500	1 180 875	1 271 325	1 341 675	1 673 325

268/180x104x79/44		SET 2 right - chaiselongue wide r.** + element 134 l.								
	LUX	E1646-5205-2L	3,08	115	11,7	1 105 500	1 180 875	1 271 325	1 341 675	1 673 325

*Explicit +/- 2 cm tolerance of all elements sizes

**This element may have a stitching on the seat cushion. Ask your representative for more details.

Załączone ceny rekomendowane mają charakter sugerowanych cen sprzedaży. Kupujący nie jest związany cenami rekomendowanymi.