

# IMPULSE

plus



**SITS**

design: SITS

## TECHNICAL SPECIFICATION

### PROFILE

COMFORT: standard plus

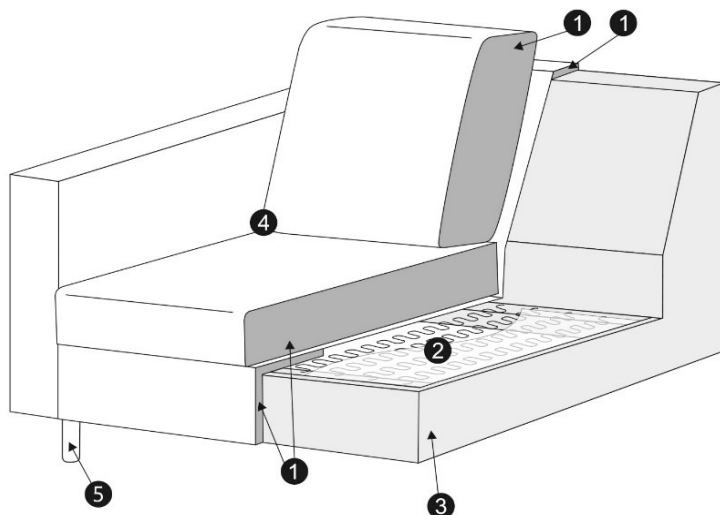

- |   |   |
|---|---|
| 1 | polyurethane foam/ high resilient polyurethane foam |
| 2 | springs   |
| 4 | solid wood and wood based elements                  |
| 4 | fabric  |
| 6 | metal (black,chrome) or solid wood legs             |

The producer reserves the right to change construction of products and compnents used due to improving durability of product and customer satisfaction without any further notice.

### UPHOLSTERY:

fabric: FC - fix cover, LC - loose cover or LCV - loose cover with velcro, leather: FC - fix cover  
COMFORT: STD - standard, PLUS - standard plus, CLS - classic or LUX

### ARMRESTS

**ARMREST I**  
cm 88 x 8 x 49 H

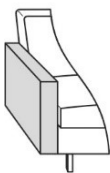

**ARMREST II**  
cm 88 x 15 x 49 H

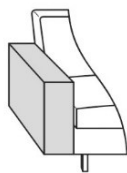

**ENDPART LEFT (or RIGHT)**  
cm 88 x 2,5 x 49 H

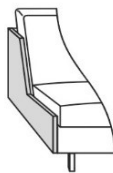

### TWO OPTIONS TO PLACE THE FEET

under armrest



under frame



### FEET

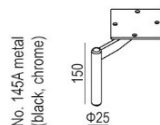
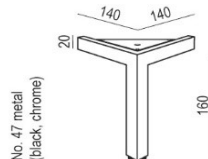
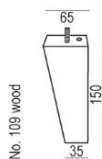

### COLOURS OF WOODEN FEET

IMPULSE  
plus



**SITS**

design: SITS

**TECHNICAL SPECIFICATION**

oak



bleached  
oak



walnut



black



IMPULSE  
plus



SITS

design: SITS

## Sales pricelist 2024

UPHOLSTERY: fabric: FC - fix cover or LC - loose cover or LCV - loose cover with velcro  
COMFORT: PLUS-standard plus

Currency: EUR

Valid from: 01.02.2024.

DIMENSION * with armrest No I and legs H-150 mm	DESCRIPTION ARTICLE No	VOL.	WEIGHT	FABRIC USAGE	I	II	III	IV	E	
<b>236x92x82/44</b>										
	<b>4 seater (two parts)</b>									
	FC	E1758-0900-2D	1,35	94	9,8	595 200	646 350	697 500	753 300	948 600
	LC	E1758-0900-6D	1,35	94	9,8	651 000	711 450	771 900	832 350	1 046 250
	COVER	E0758-0900-6	0,04	6	9,8	260 400	283 650	306 900	330 150	413 850
	LCV	E1758-0900-4D	1,35	94	9,8	669 600	730 050	790 500	846 300	1 064 850
COVER velcro	E0758-0900-4	0,04	6	9,8	274 350	292 950	320 850	344 100	427 800	
<b>218x92x82/44</b>										
	<b>3 seater</b>									
	FC	E1758-0400-2D	1,25	58	9,2	497 550	562 650	618 450	678 900	846 300
	LC	E1758-0400-6D	1,25	58	9,2	558 000	618 450	678 900	748 650	934 650
	COVER	E0758-0400-6	0,04	8	9,2	218 550	241 800	274 350	292 950	362 700
	LCV	E1758-0400-4D	1,25	58	9,2	562 650	632 400	692 850	757 950	948 600
COVER velcro	E0758-0400-4	0,04	8	9,2	223 200	246 450	279 000	302 250	372 000	
<b>196x92x82/44</b>										
	<b>2,5 seater</b>									
	FC	E1758-0300-2D	1,14	57	8,5	455 700	511 500	567 300	627 750	781 200
	LC	E1758-0300-6D	1,14	57	8,5	506 850	567 300	627 750	697 500	864 900
	COVER	E0758-0300-6	0,04	5	8,5	195 300	223 200	246 450	279 000	334 800
	LCV	E1758-0300-4D	1,14	57	8,5	525 450	576 600	637 050	711 450	874 200
COVER velcro	E0758-0300-4	0,04	5	8,5	204 600	227 850	255 750	283 650	348 750	
<b>156x92x82/44</b>										
	<b>2 seater</b>									
	FC	E1758-0200-2D	0,90	47	7,2	427 800	465 000	511 500	567 300	706 800
	LC	E1758-0200-6D	0,90	47	7,2	465 000	511 500	567 300	627 750	781 200
	COVER	E0758-0200-6	0,02	4	7,2	186 000	204 600	223 200	246 450	306 900
	LCV	E1758-0200-4D	0,90	47	7,2	469 650	530 100	576 600	637 050	795 150
COVER velcro	E0758-0200-4	0,02	4	7,2	190 650	209 250	227 850	255 750	311 550	
<b>81x92x82/44</b>										
	<b>armchair</b>									
	FC	E1758-0000-2D	0,50	31	4,5	292 950	320 850	353 400	385 950	478 950
	LC	E1758-0000-6D	0,50	31	4,5	330 150	353 400	385 950	432 450	534 750
COVER	E0758-0000-6	0,02	3	4,5	130 200	153 450	162 750	176 700	209 250	

IMPULSE  
plus



SITS

design: SITS

## Sales pricelist 2024

UPHOLSTERY: fabric: FC - fix cover or LC - loose cover or LCV - loose cover with velcro  
COMFORT: PLUS-standard plus

Currency: EUR

Valid from: 01.02.2024.

DIMENSION * with armrest No I and legs H-150 mm	DESCRIPTION ARTICLE No	VOL.	WEIGHT	FABRIC USAGE	I	II	III	IV	E
	LCV E1758-0000-4D	0,50	31	4,5	334 800	362 700	399 900	441 750	548 700
	COVER velcro E0758-0000-4	0,02	3	4,5	139 500	158 100	167 400	176 700	218 550

64x80x44	footstool									
	FC	E1758-1045-2S	0,20	12	1,7	176 700	190 650	195 300	218 550	260 400
	LC	E1758-1045-6S	0,20	12	1,7	190 650	204 600	223 200	241 800	302 250
	COVER	E0758-1045-6	0,01	1	1,7	79 050	83 700	88 350	93 000	120 900
	LCV	E1758-1045-4S	0,20	12	1,7	190 650	209 250	227 850	241 800	306 900
	COVER velcro	E0758-1045-4	0,01	1	1,7	79 050	83 700	88 350	97 650	120 900

60xØ16x62	headrest 60/16 with roll (foam filling)									
	LC	E1826-1660-4	0,10	3	0,7	79 050	83 700	93 000	93 000	116 250
	COVER	E0826-1660-4	0,01	1	0,7	51 150	51 150	55 800	55 800	60 450

56x7x25	cushion									
	LC	E1758-5625-4	0,01	1	0,8	65 100	65 100	74 400	79 050	93 000
	COVER	E0758-5625-4	0,01	1	0,8	46 500	46 500	46 500	51 150	55 800

armrest protection / set of 2										
	LC	E1758-1900-0	0,01	1	0,7	46 500	55 800	60 450	65 100	88 350

### elements for building sets:

228x92x82/44	4 seater left									
	FC	E1758-0920-2D	1,31	88	9,3	534 750	576 600	632 400	678 900	846 300
	LC	E1758-0920-6D	1,31	88	9,3	585 900	637 050	692 850	748 650	934 650
	COVER	E0758-0920-6	0,04	6	9,3	227 850	246 450	279 000	292 950	362 700
	LCV	E1758-0920-4D	1,31	88	9,3	604 500	655 650	711 450	776 550	957 900
	COVER velcro	E0758-0920-4	0,04	6	9,3	232 500	255 750	283 650	302 250	372 000

228x92x82/44	4 seater right									
	FC	E1758-0910-2D	1,31	88	9,3	534 750	576 600	632 400	678 900	846 300



Sales pricelist 2024

UPHOLSTERY: fabric: FC - fix cover or LC - loose cover or LCV - loose cover with velcro  
COMFORT: PLUS-standard plus

Currency: EUR

Valid from: 01.02.2024.

DIMENSION * with armrest No I and legs H-150 mm	DESCRIPTION ARTICLE No	VOL	WEIGHT	FABRIC USAGE	I	II	III	IV	E
	LC E1758-0910-6D	1,31	88	9,3	585 900	637 050	692 850	748 650	934 650
	COVER E0758-0910-6	0,04	6	9,3	227 850	246 450	279 000	292 950	362 700
	LCV E1758-0910-4D	1,31	88	9,3	604 500	655 650	711 450	776 550	957 900
	COVER velcro E0758-0910-4	0,04	6	9,3	232 500	255 750	283 650	302 250	372 000
<b>220x92x82/44 4 seater without armrests</b>									
	FC E1758-0930-2D	1,26	77	8,3	465 000	506 850	558 000	599 850	748 650
	LC E1758-0930-6D	1,26	77	8,3	511 500	562 650	604 500	660 300	832 350
	COVER E0758-0930-6	0,04	5	8,3	204 600	218 550	232 500	260 400	325 500
	LCV E1758-0930-4D	1,26	77	8,3	539 400	576 600	632 400	683 550	855 600
	COVER velcro E0758-0930-4	0,04	5	8,3	209 250	223 200	246 450	274 350	330 150
<b>210x92x82/44 3 seater left</b>									
	FC E1758-0420-2D	1,21	53	8,3	409 200	460 350	497 550	558 000	683 550
	LC E1758-0420-6D	1,21	53	8,3	455 700	506 850	558 000	604 500	753 300
	COVER E0758-0420-6	0,04	5	8,3	181 350	195 300	218 550	232 500	292 950
	LCV E1758-0420-4D	1,21	53	8,3	465 000	534 750	571 950	632 400	781 200
	COVER velcro E0758-0420-4	0,04	5	8,3	186 000	204 600	223 200	246 450	306 900
<b>210x92x82/44 3 seater right</b>									
	FC E1758-0410-2D	1,21	53	8,3	409 200	460 350	497 550	558 000	683 550
	LC E1758-0410-6D	1,21	53	8,3	455 700	506 850	558 000	604 500	753 300
	COVER E0758-0410-6	0,04	5	8,3	181 350	195 300	218 550	232 500	292 950
	LCV E1758-0410-4D	1,21	53	8,3	465 000	534 750	571 950	632 400	781 200
	COVER velcro E0758-0410-4	0,04	5	8,3	186 000	204 600	223 200	246 450	306 900
<b>202x92x82/44 3 seater without armrests</b>									
	FC E1758-0430-2D	1,16	47	7,6	353 400	399 900	441 750	478 950	599 850
	LC E1758-0430-6D	1,16	47	7,6	385 950	441 750	478 950	534 750	660 300
	COVER E0758-0430-6	0,04	4	7,6	162 750	176 700	190 650	209 250	260 400
	LCV E1758-0430-4D	1,16	47	7,6	404 550	455 700	488 250	558 000	683 550
	COVER velcro E0758-0430-4	0,04	4	7,6	167 400	181 350	195 300	218 550	274 350

IMPULSE  
plus



SITS



design: SITS

## Sales pricelist 2024

UPHOLSTERY: fabric: FC - fix cover or LC - loose cover or LCV - loose cover with velcro  
COMFORT: PLUS-standard plus

Currency: EUR

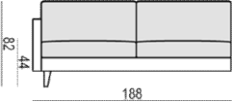
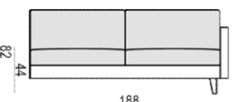
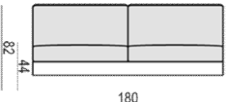
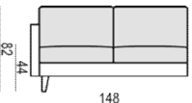
Valid from: 01.02.2024.

DIMENSION * with armrest No I and legs H-150 mm	DESCRIPTION ARTICLE No	VOL.	WEIGHT	FABRIC USAGE	I	II	III	IV	E
	<b>2,5 seater left</b>								
	FC E1758-0320-2D	1,08	50	7,6	385 950	437 100	469 650	511 500	646 350
	LC E1758-0320-6D	1,08	50	7,6	437 100	469 650	530 100	571 950	706 800
	COVER E0758-0320-6	0,04	5	7,6	176 700	186 000	204 600	223 200	279 000
	LCV E1758-0320-4D	1,08	50	7,6	446 400	483 600	548 700	595 200	730 050
COVER velcro E0758-0320-4	0,04	5	7,6	181 350	190 650	209 250	227 850	288 300	
	<b>2,5 seater right</b>								
	FC E1758-0310-2D	1,08	50	7,6	385 950	437 100	469 650	511 500	646 350
	LC E1758-0310-6D	1,08	50	7,6	437 100	469 650	530 100	571 950	706 800
	COVER E0758-0310-6	0,04	5	7,6	176 700	186 000	204 600	223 200	279 000
	LCV E1758-0310-4D	1,08	50	7,6	446 400	483 600	548 700	595 200	730 050
COVER velcro E0758-0310-4	0,04	5	7,6	181 350	190 650	209 250	227 850	288 300	
	<b>2,5 seater without armrests</b>								
	FC E1758-0330-2D	1,04	42	6,9	325 500	362 700	399 900	441 750	548 700
	LC E1758-0330-6D	1,04	42	6,9	353 400	399 900	441 750	478 950	599 850
	COVER E0758-0330-6	0,04	4	6,9	153 450	167 400	176 700	190 650	232 500
	LCV E1758-0330-4D	1,04	42	6,9	367 350	409 200	455 700	488 250	627 750
COVER velcro E0758-0330-4	0,04	4	6,9	158 100	167 400	181 350	195 300	241 800	
	<b>2 seater left</b>								
	FC E1758-0220-2D	0,90	39	6,3	344 100	372 000	409 200	446 400	562 650
	LC E1758-0220-6D	0,90	39	6,3	372 000	423 150	455 700	488 250	609 150
	COVER E0758-0220-6	0,04	4	6,3	158 100	172 050	181 350	195 300	241 800
	LCV E1758-0220-4D	0,90	39	6,3	385 950	437 100	465 000	511 500	637 050
COVER velcro E0758-0220-4	0,04	4	6,3	162 750	176 700	186 000	195 300	246 450	
	<b>2 seater right</b>								
	FC E1758-0210-2D	0,90	39	6,3	344 100	372 000	409 200	446 400	562 650
	LC E1758-0210-6D	0,90	39	6,3	372 000	423 150	455 700	488 250	609 150
COVER E0758-0210-6	0,04	4	6,3	158 100	172 050	181 350	195 300	241 800	

IMPULSE  
plus



SITS



design: SITS

## Sales pricelist 2024

UPHOLSTERY: fabric: FC - fix cover or LC - loose cover or LCV - loose cover with velcro  
COMFORT: PLUS-standard plus

Currency: EUR

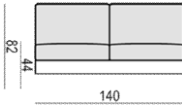
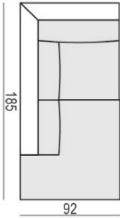
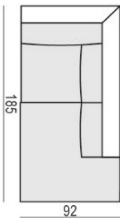
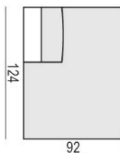
Valid from: 01.02.2024.

DIMENSION * with armrest No I and legs H-150 mm	DESCRIPTION ARTICLE No		VOL.	WEIGHT	FABRIC USAGE	I	II	III	IV	E
	LCV	<b>E1758-0210-4D</b>	0,90	39	6,3	<b>385 950</b>	<b>437 100</b>	<b>465 000</b>	<b>511 500</b>	<b>637 050</b>
	COVER velcro	<b>E0758-0210-4</b>	0,04	4	6,3	<b>162 750</b>	<b>176 700</b>	<b>186 000</b>	<b>195 300</b>	<b>246 450</b>
<b>140x92x82/44</b>	<b>2 seater without armrests</b>									
	FC	<b>E1758-0230-2D</b>	0,81	37	5,5	<b>274 350</b>	<b>306 900</b>	<b>334 800</b>	<b>367 350</b>	<b>460 350</b>
	LC	<b>E1758-0230-6D</b>	0,81	37	5,5	<b>302 250</b>	<b>344 100</b>	<b>367 350</b>	<b>404 550</b>	<b>506 850</b>
	COVER	<b>E0758-0230-6</b>	0,04	4	5,5	<b>120 900</b>	<b>139 500</b>	<b>158 100</b>	<b>167 400</b>	<b>195 300</b>
	LCV	<b>E1758-0230-4D</b>	0,81	37	5,5	<b>311 550</b>	<b>353 400</b>	<b>381 300</b>	<b>423 150</b>	<b>534 750</b>
	COVER velcro	<b>E0758-0230-4</b>	0,04	4	5,5	<b>120 900</b>	<b>153 450</b>	<b>162 750</b>	<b>172 050</b>	<b>204 600</b>
<b>92x185x82/44</b>	<b>divan left</b>									
	FC	<b>E1758-1230-2D</b>	1,18	47	7,8	<b>409 200</b>	<b>455 700</b>	<b>488 250</b>	<b>548 700</b>	<b>678 900</b>
	LC	<b>E1758-1230-6D</b>	1,18	47	7,8	<b>455 700</b>	<b>497 550</b>	<b>548 700</b>	<b>599 850</b>	<b>748 650</b>
	COVER	<b>E0758-1230-6</b>	0,04	5	7,8	<b>181 350</b>	<b>195 300</b>	<b>218 550</b>	<b>232 500</b>	<b>292 950</b>
	LCV	<b>E1758-1230-4D</b>	1,18	47	7,8	<b>465 000</b>	<b>530 100</b>	<b>567 300</b>	<b>627 750</b>	<b>776 550</b>
	COVER velcro	<b>E0758-1230-4</b>	0,04	5	7,8	<b>186 000</b>	<b>204 600</b>	<b>223 200</b>	<b>241 800</b>	<b>302 250</b>
<b>92x185x82/44</b>	<b>divan right</b>									
	FC	<b>E1758-1231-2D</b>	1,18	47	7,8	<b>409 200</b>	<b>455 700</b>	<b>488 250</b>	<b>548 700</b>	<b>678 900</b>
	LC	<b>E1758-1231-6D</b>	1,18	47	7,8	<b>455 700</b>	<b>497 550</b>	<b>548 700</b>	<b>599 850</b>	<b>748 650</b>
	COVER	<b>E0758-1231-6</b>	0,04	5	7,8	<b>181 350</b>	<b>195 300</b>	<b>218 550</b>	<b>232 500</b>	<b>292 950</b>
	LCV	<b>E1758-1231-4D</b>	1,18	47	7,8	<b>465 000</b>	<b>530 100</b>	<b>567 300</b>	<b>627 750</b>	<b>776 550</b>
	COVER velcro	<b>E0758-1231-4</b>	0,04	5	7,8	<b>186 000</b>	<b>204 600</b>	<b>223 200</b>	<b>241 800</b>	<b>302 250</b>
<b>92x124x82/44</b>	<b>bench left</b>									
	FC	<b>E1758-1310-2D</b>	0,70	35	4,5	<b>274 350</b>	<b>302 250</b>	<b>325 500</b>	<b>348 750</b>	<b>437 100</b>
	LC	<b>E1758-1310-6D</b>	0,70	35	4,5	<b>302 250</b>	<b>330 150</b>	<b>353 400</b>	<b>381 300</b>	<b>469 650</b>
	COVER	<b>E0758-1310-6</b>	0,04	3	4,5	<b>120 900</b>	<b>130 200</b>	<b>153 450</b>	<b>162 750</b>	<b>186 000</b>
	LCV	<b>E1758-1310-4D</b>	0,70	35	4,5	<b>311 550</b>	<b>344 100</b>	<b>367 350</b>	<b>399 900</b>	<b>483 600</b>
	COVER velcro	<b>E0758-1310-4</b>	0,04	3	4,5	<b>120 900</b>	<b>139 500</b>	<b>158 100</b>	<b>162 750</b>	<b>190 650</b>
<b>92x124x82/44</b>	<b>bench right</b>									
	FC	<b>E1758-1311-2D</b>	0,70	35	4,5	<b>274 350</b>	<b>302 250</b>	<b>325 500</b>	<b>348 750</b>	<b>437 100</b>

IMPULSE  
plus



SITS

design: SITS

## Sales pricelist 2024

UPHOLSTERY: fabric: FC - fix cover or LC - loose cover or LCV - loose cover with velcro  
COMFORT: PLUS-standard plus

Currency: EUR

Valid from: 01.02.2024.

DIMENSION * with armrest No I and legs H-150 mm	DESCRIPTION ARTICLE No	VOL.	WEIGHT	FABRIC USAGE	I	II	III	IV	E
	LC E1758-1311-6D	0,70	35	4,5	302 250	330 150	353 400	381 300	469 650
	COVER E0758-1311-6	0,04	3	4,5	120 900	130 200	153 450	162 750	186 000
	LCV E1758-1311-4D	0,70	35	4,5	311 550	344 100	367 350	399 900	483 600
	COVER velcro E0758-1311-4	0,04	3	4,5	120 900	139 500	158 100	162 750	190 650

92x92x82/44	corner 90°									
	FC E1758-1302-2D	0,51	27	4,4	260 400	292 950	311 550	334 800	423 150	
	LC E1758-1302-6D	0,51	27	4,4	292 950	325 500	348 750	367 350	460 350	
	COVER E0758-1302-6	0,02	3	4,4	116 250	130 200	153 450	158 100	181 350	
	LCV E1758-1302-4D	0,51	27	4,4	306 900	334 800	362 700	381 300	469 650	
	COVER velcro E0758-1302-4	0,02	3	4,4	120 900	130 200	153 450	162 750	186 000	

88x49x2,5	endpart left									
	FC E1758-1960-2	0,02	3	1,1	79 050	83 700	93 000	97 650	120 900	

88x49x2,5	endpart right									
	FC E1758-1950-2	0,02	3	1,1	79 050	83 700	93 000	97 650	120 900	

### suggested sets:

282/185x92x82/44	SET 4 left - 2,5 seater r. + divan l.									
	FC E1758-5308-2D	2,20	96	15,4	818 400	916 050	1 009 050	1 116 000	1 395 000	
	LC E1758-5308-6D	2,20	96	15,4	902 100	1 009 050	1 116 000	1 227 600	1 529 850	
	COVER E0758-5308-6	0,08	9	15,4	348 750	399 900	437 100	469 650	595 200	
	LCV E1758-5308-4D	2,20	96	15,4	916 050	1 027 650	1 129 950	1 250 850	1 557 750	
	COVER velcro E0758-5308-4	0,08	9	15,4	362 700	409 200	446 400	488 250	609 150	

282/185x92x82/44	SET 4 right - 2,5 seater l. + divan r.									
	FC E1758-5307-2D	2,20	96	15,4	818 400	916 050	1 009 050	1 116 000	1 395 000	



IMPULSE  
plus



SITS

design: SITS

## Sales pricelist 2024

UPHOLSTERY: fabric: FC - fix cover or LC - loose cover or LCV - loose cover with velcro  
COMFORT: PLUS-standard plus

Currency: EUR

Valid from: 01.02.2024.

DIMENSION * with armrest No I and legs H-150 mm	DESCRIPTION ARTICLE No	VOL.	WEIGHT	FABRIC USAGE	I	II	III	IV	E	
	LC	<b>E1758-5307-6D</b>	2,20	96	15,4	<b>902 100</b>	<b>1 009 050</b>	<b>1 116 000</b>	<b>1 227 600</b>	<b>1 529 850</b>
	COVER	<b>E0758-5307-6</b>	0,08	9	15,4	<b>348 750</b>	<b>399 900</b>	<b>437 100</b>	<b>469 650</b>	<b>595 200</b>
	LCV	<b>E1758-5307-4D</b>	2,20	96	15,4	<b>916 050</b>	<b>1 027 650</b>	<b>1 129 950</b>	<b>1 250 850</b>	<b>1 557 750</b>
	COVER velcro	<b>E0758-5307-4</b>	0,08	9	15,4	<b>362 700</b>	<b>409 200</b>	<b>446 400</b>	<b>488 250</b>	<b>609 150</b>

240/185x92x82/44	SET 5 left - 2 seater r. + divan l.									
	FC	<b>E1758-5208-2D</b>	1,90	88	14,0	<b>748 650</b>	<b>841 650</b>	<b>920 700</b>	<b>1 023 000</b>	<b>1 278 750</b>
	LC	<b>E1758-5208-6D</b>	1,90	88	14,0	<b>832 350</b>	<b>920 700</b>	<b>1 023 000</b>	<b>1 120 650</b>	<b>1 404 300</b>
	COVER	<b>E0758-5208-6</b>	0,08	8	14,0	<b>325 500</b>	<b>362 700</b>	<b>404 550</b>	<b>437 100</b>	<b>544 050</b>
	LCV	<b>E1758-5208-4D</b>	1,90	88	14,0	<b>841 650</b>	<b>948 600</b>	<b>1 046 250</b>	<b>1 148 550</b>	<b>1 427 550</b>
	COVER velcro	<b>E0758-5208-4</b>	0,08	8	14,0	<b>330 150</b>	<b>372 000</b>	<b>413 850</b>	<b>446 400</b>	<b>558 000</b>

240/185x92x82/44	SET 5 right - 2 seater l. + divan r.									
	FC	<b>E1758-5207-2D</b>	1,90	88	14,0	<b>748 650</b>	<b>841 650</b>	<b>920 700</b>	<b>1 023 000</b>	<b>1 278 750</b>
	LC	<b>E1758-5207-6D</b>	1,90	88	14,0	<b>832 350</b>	<b>920 700</b>	<b>1 023 000</b>	<b>1 120 650</b>	<b>1 404 300</b>
	COVER	<b>E0758-5207-6</b>	0,08	8	14,0	<b>325 500</b>	<b>362 700</b>	<b>404 550</b>	<b>437 100</b>	<b>544 050</b>
	LCV	<b>E1758-5207-4D</b>	1,90	88	14,0	<b>841 650</b>	<b>948 600</b>	<b>1 046 250</b>	<b>1 148 550</b>	<b>1 427 550</b>
	COVER velcro	<b>E0758-5207-4</b>	0,08	8	14,0	<b>330 150</b>	<b>372 000</b>	<b>413 850</b>	<b>446 400</b>	<b>558 000</b>

\*Explicit +/- 2 cm tolerance of all elements sizes