

BRANDON STANDARD

tea&book



SITS
— comfortable life

design: SITS

TECHNICAL SPECIFICATION

PROFILE

COMFORT: standard

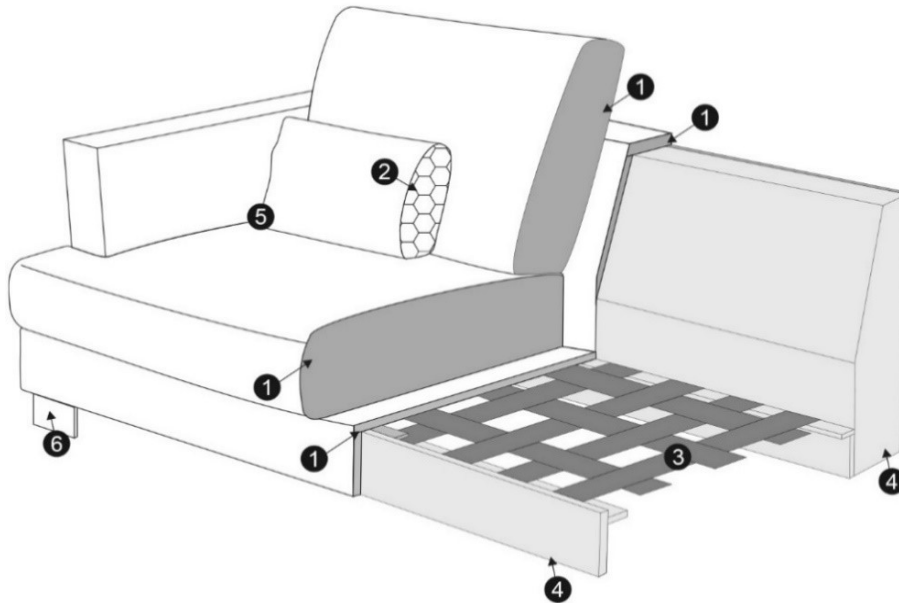

- | | |
|---|--|
| 1 | polyurethane foam/high resilient polyurethane foam |
| 2 | silicone balls |
| 3 | upholstery belts |
| 4 | solid wood and wood based elements |
| 5 | fabric |
| 6 | legs: solid wood or metal (black, , chrome,) |

The producer reserves the right to change construction of products and components used due to improving durability of product and customer satisfaction without any further notice.

UPHOLSTERY:

fabric: FC - fix cover or LC - loose cover, leather: FC - fix cover, COMFORTS: lux or STD - standard

FEET

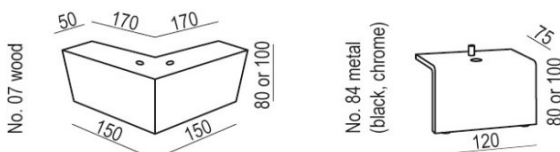

COLOURS OF WOODEN FEET



FOOTSTOOL MOUNTING POSSIBILITIES



TECHNICAL SPECIFICATION

3 seater

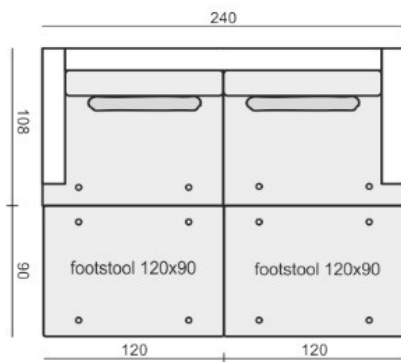

3 seater left (or right)

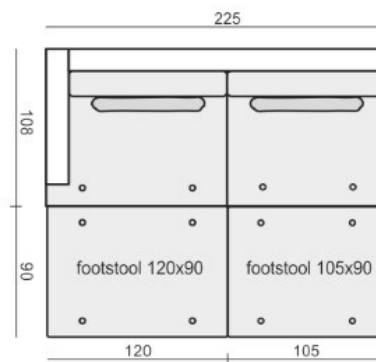

armchair
left (or right)

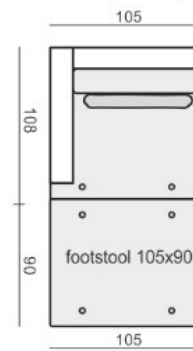

2 seater

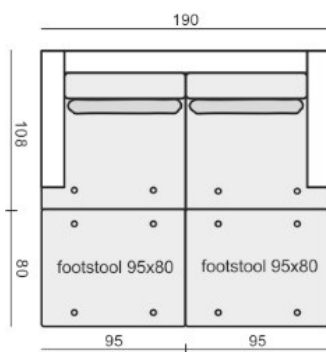

2 seater left (or right)

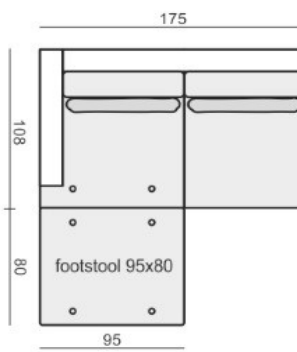

armchair wide
left (or right)

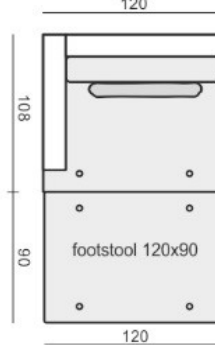

armchair wide
without armrests

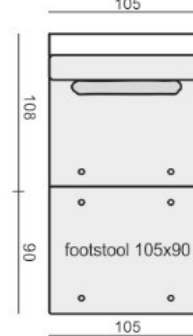



Sales pricelist 2024

UPHOLSTERY: fabric: FC - fix cover or LC - loose cover, COMFORTS: STD - standard Currency: EUR Valid from: 01.02.2024.

| DIMENSION* with legs H-80 mm | DESCRIPTION ARTICLE No | VOL. | WEIGHT | FABRIC USAGE | I | II | III | IV | E |
|----------------------------------|---|------|--------|-----------------|---------|-----------|-----------|-----------|-----------|
| | 3 seater | | | | | | | | |
| | FC E1649-0400-2S | 1,70 | 87 | 13,4 | 720 750 | 785 850 | 860 250 | 930 000 | 1 162 500 |
| | LC E1649-0400-6S | 1,70 | 87 | 13,4 | 790 500 | 869 550 | 943 950 | 1 023 000 | 1 274 100 |
| | COVER E0649-0400-6 | 0,04 | 8 | 13,4 | 288 300 | 385 950 | 478 950 | 567 300 | 706 800 |
| | 3 seater (two parts) | | | | | | | | |
| | FC E1649-0500-2S | 1,70 | 88 | 13,9 | 757 950 | 827 700 | 902 100 | 967 200 | 1 213 650 |
| | LC E1649-0500-6S | 1,70 | 88 | 13,4 | 832 350 | 906 750 | 995 100 | 1 060 200 | 1 329 900 |
| | COVER E0649-0500-6 | 0,04 | 8 | 13,4 | 292 950 | 390 600 | 483 600 | 571 950 | 716 100 |
| | 2 seater | | | | | | | | |
| | FC E1649-0200-2S | 1,30 | 68 | 11,3 | 646 350 | 683 550 | 748 650 | 804 450 | 1 004 400 |
| | LC E1649-0200-6S | 1,30 | 63 | 11,4 | 706 800 | 753 300 | 818 400 | 883 500 | 1 106 700 |
| | COVER E0649-0200-6 | 0,02 | 7 | 11,4 | 265 050 | 330 150 | 413 850 | 502 200 | 618 450 |
| | armchair wide | | | | | | | | |
| | FC E1649-0100-2S | 1,00 | 56 | 8,1 | 465 000 | 511 500 | 544 050 | 590 550 | 739 350 |
| | LC E1649-0100-6S | 1,00 | 56 | 7,7 | 511 500 | 558 000 | 595 200 | 646 350 | 804 450 |
| | COVER E0649-0100-6 | 0,02 | 5 | 7,7 | 181 350 | 232 500 | 288 300 | 348 750 | 432 450 |
| | armchair | | | | | | | | |
| | FC E1649-0000-2S | 0,90 | 55 | 7,4 | 423 150 | 469 650 | 506 850 | 558 000 | 683 550 |
| | LC E1649-0000-6S | 0,90 | 54 | 7,5 | 465 000 | 520 800 | 548 700 | 613 800 | 757 950 |
| | COVER E0649-0000-6 | 0,02 | 4 | 7,5 | 176 700 | 227 850 | 279 000 | 330 150 | 413 850 |
| | divan left /freestanding | | | | | | | | |
| | FC E1649-1235-2S | 2,00 | 81 | 14,1 | 850 950 | 930 000 | 1 018 350 | 1 111 350 | 1 371 750 |
| | LC E1649-1235-6S | 2,00 | 81 | 14,1 | 939 300 | 1 023 000 | 1 120 650 | 1 222 950 | 1 511 250 |
| | COVER E0649-0235-6 | 0,04 | 8 | 14,1 | 353 400 | 478 950 | 585 900 | 688 200 | 864 900 |
| | divan left (two parts) /freestanding | | | | | | | | |
| | FC E1649-1236-2S | 2,00 | 81 | 14,1 | 902 100 | 985 800 | 1 069 500 | 1 162 500 | 1 427 550 |
| | LC E1649-1236-6S | 2,00 | 81 | 14,1 | 995 100 | 1 074 150 | 1 171 800 | 1 274 100 | 1 567 050 |
| | COVER E0649-1236-6 | 0,04 | 8 | 14,1 | 353 400 | 478 950 | 585 900 | 688 200 | 864 900 |
| divan right /freestanding | | | | | | | | | |



Sales pricelist 2024

| UPHOLSTERY: fabric: FC - fix cover or LC - loose cover, COMFORTS: STD - standard | | | | Currency: EUR | | Valid from: 01.02.2024. | | | | | |
|--|--|--|----------------------|---------------|-----------------|-------------------------|----------------|------------------|------------------|------------------|------------------|
| DIMENSION* with legs H-80 mm | | DESCRIPTION ARTICLE No | VOL. | WEIGHT | FABRIC USAGE | I | II | III | IV | E | |
| | | FC | E1649-1234-2S | 2,00 | 81 | 14,1 | 850 950 | 930 000 | 1 018 350 | 1 111 350 | 1 371 750 |
| | | LC | E1649-1234-6S | 2,00 | 81 | 14,1 | 939 300 | 1 023 000 | 1 120 650 | 1 222 950 | 1 511 250 |
| | | COVER | E0649-0234-6 | 0,04 | 8 | 14,1 | 353 400 | 478 950 | 585 900 | 688 200 | 864 900 |
| 126x235x83/46 | | divan right (two parts) /freestanding | | | | | | | | | |
| | | FC | E1649-1237-2S | 2,00 | 81 | 14,1 | 902 100 | 985 800 | 1 069 500 | 1 162 500 | 1 427 550 |
| | | LC | E1649-1237-6S | 2,00 | 81 | 14,1 | 995 100 | 1 074 150 | 1 171 800 | 1 274 100 | 1 567 050 |
| | | COVER | E0649-1237-6 | 0,04 | 8 | 14,1 | 353 400 | 478 950 | 585 900 | 688 200 | 864 900 |
| 95x80x46 | | footstool 95x80 | | | | | | | | | |
| | | FC | E1649-1055-2S | 0,30 | 22 | 3,1 | 265 050 | 274 350 | 288 300 | 297 600 | 376 650 |
| | | LC | E1649-1055-6S | 0,30 | 22 | 3,2 | 283 650 | 297 600 | 311 550 | 330 150 | 409 200 |
| | | COVER | E0649-1055-6 | 0,02 | 2 | 3,2 | 88 350 | 111 600 | 148 800 | 162 750 | 195 300 |
| 105x90x46 | | footstool 105x90 | | | | | | | | | |
| | | FC | E1649-1060-2S | 0,40 | 26 | 3,5 | 279 000 | 292 950 | 316 200 | 330 150 | 413 850 |
| | | LC | E1649-1060-6S | 0,40 | 26 | 3,5 | 306 900 | 325 500 | 348 750 | 362 700 | 446 400 |
| | | COVER | E0649-1060-6 | 0,02 | 2 | 3,5 | 93 000 | 120 900 | 158 100 | 176 700 | 213 900 |
| 120x90x46 | | footstool 120x90 | | | | | | | | | |
| | | FC | E1649-1065-2S | 0,50 | 29 | 4,2 | 292 950 | 316 200 | 334 800 | 353 400 | 437 100 |
| | | LC | E1649-1065-6S | 0,50 | 29 | 4,2 | 325 500 | 348 750 | 376 650 | 390 600 | 478 950 |
| | | COVER | E0649-1065-6 | 0,02 | 2 | 4,2 | 102 300 | 148 800 | 172 050 | 195 300 | 241 800 |
| 76x25 | | lumbar cushion | | | | | | | | | |
| | | LC | E1649-7625-4S | 0,03 | 2 | 1,0 | 46 500 | 55 800 | 55 800 | 60 450 | 69 750 |
| | | COVER | E0649-7625-4 | 0,01 | 1 | 1,0 | 37 200 | 37 200 | 37 200 | 41 850 | 41 850 |
| 70xØ15x60 | | headrest 70/15 with roll | | | | | | | | | |
| | | FC | E1826-1570-4 | 0,0 | 3 | 0,9 | 69 750 | 79 050 | 83 700 | 83 700 | 97 650 |



Sales pricelist 2024

UPHOLSTERY: fabric: FC - fix cover or LC - loose cover, COMFORTS: STD - standard Currency: EUR Valid from: 01.02.2024.

| DIMENSION* with legs H-80 mm | DESCRIPTION ARTICLE No | VOL. | WEIGHT | FABRIC USAGE | I | II | III | IV | E |
|---------------------------------|---------------------------|------|--------|-----------------|---|----|-----|----|---|
|---------------------------------|---------------------------|------|--------|-----------------|---|----|-----|----|---|

| x | | | | | | | | | | |
|---|----|--------------|-----|---|-----|--------|--------|--------|--------|--------|
| armrest protection /set of 2 | | | | | | | | | | |
|  | FC | E1649-1900-0 | 0,0 | 1 | 1,1 | 41 850 | 51 150 | 55 800 | 60 450 | 83 700 |

elements for building sets:

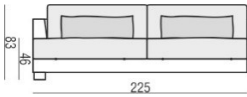
| 225x108x83/46 | | | | | | | | | | |
|---|-------|---------------|------|----|------|---------|---------|---------|---------|-----------|
| 3 seater left | | | | | | | | | | |
|  | FC | E1649-0420-2S | 1,60 | 75 | 12,3 | 660 300 | 720 750 | 785 850 | 850 950 | 1 060 200 |
| | LC | E1649-0420-6S | 1,60 | 75 | 12,3 | 734 700 | 790 500 | 869 550 | 939 300 | 1 162 500 |
| | COVER | E0649-0420-6 | 0,04 | 7 | 12,3 | 269 700 | 353 400 | 441 750 | 534 750 | 660 300 |

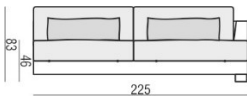
| 225x108x83/46 | | | | | | | | | | |
|--|-------|---------------|------|----|------|---------|---------|---------|---------|-----------|
| 3 seater right | | | | | | | | | | |
|  | FC | E1649-0410-2S | 1,60 | 75 | 12,3 | 660 300 | 720 750 | 785 850 | 850 950 | 1 060 200 |
| | LC | E1649-0410-6S | 1,60 | 75 | 12,3 | 734 700 | 790 500 | 869 550 | 939 300 | 1 162 500 |
| | COVER | E0649-0410-6 | 0,04 | 7 | 12,3 | 269 700 | 353 400 | 441 750 | 534 750 | 660 300 |

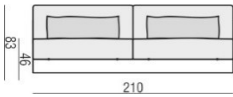
| 210x108x83/46 | | | | | | | | | | |
|---|-------|---------------|------|----|------|---------|---------|---------|---------|-----------|
| 3 seater without armrests | | | | | | | | | | |
|  | FC | E1649-0430-2S | 1,50 | 66 | 11,2 | 595 200 | 655 650 | 711 450 | 771 900 | 957 900 |
| | LC | E1649-0430-6S | 1,50 | 66 | 11,6 | 655 650 | 720 750 | 776 550 | 841 650 | 1 050 900 |
| | COVER | E0649-0430-6 | 0,04 | 7 | 11,6 | 246 450 | 330 150 | 413 850 | 502 200 | 618 450 |

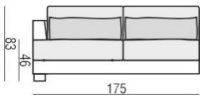
| 175x108x83/46 | | | | | | | | | | |
|---|-------|---------------|------|----|------|---------|---------|---------|---------|---------|
| 2 seater left | | | | | | | | | | |
|  | FC | E1649-0220-2S | 1,20 | 63 | 10,5 | 562 650 | 618 450 | 660 300 | 716 100 | 897 450 |
| | LC | E1649-0220-6S | 1,20 | 63 | 10,4 | 618 450 | 674 250 | 734 700 | 785 850 | 976 500 |
| | COVER | E0649-0220-6 | 0,04 | 6 | 10,4 | 232 500 | 306 900 | 385 950 | 446 400 | 558 000 |

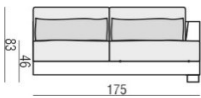
| 175x108x83/46 | | | | | | | | | | |
|---|-------|---------------|------|----|------|---------|---------|---------|---------|---------|
| 2 seater right | | | | | | | | | | |
|  | FC | E1649-0210-2S | 1,20 | 63 | 10,5 | 562 650 | 618 450 | 660 300 | 716 100 | 897 450 |
| | LC | E1649-0210-6S | 1,20 | 63 | 10,4 | 618 450 | 674 250 | 734 700 | 785 850 | 976 500 |
| | COVER | E0649-0210-6 | 0,04 | 6 | 10,4 | 232 500 | 306 900 | 385 950 | 446 400 | 558 000 |

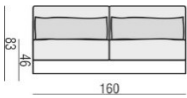
| 160x108x83/46 | | | | | | | | | | |
|---|-------|---------------|------|----|-----|---------|---------|---------|---------|---------|
| 2 seater without armrests | | | | | | | | | | |
|  | FC | E1649-0230-2S | 1,12 | 60 | 9,3 | 478 950 | 539 400 | 585 900 | 627 750 | 781 200 |
| | LC | E1649-0230-6S | 1,12 | 60 | 9,3 | 530 100 | 590 550 | 641 700 | 683 550 | 860 250 |
| | COVER | E0649-0120-6 | 0,04 | 6 | 9,3 | 204 600 | 288 300 | 353 400 | 409 200 | 506 850 |

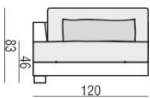
| 120x108x83/46 | | | | | | | | | | |
|---|-------|---------------|------|----|-----|---------|---------|---------|---------|---------|
| armchair wide left | | | | | | | | | | |
|  | FC | E1649-0120-2S | 0,80 | 44 | 7,0 | 390 600 | 423 150 | 465 000 | 506 850 | 623 100 |
| | LC | E1649-0120-6S | 0,80 | 44 | 7,0 | 423 150 | 465 000 | 511 500 | 548 700 | 683 550 |
| | COVER | E0649-0120-6 | 0,02 | 4 | 7,0 | 172 050 | 204 600 | 269 700 | 306 900 | 385 950 |

| 120x108x83/46 | | | | | | | | | | |
|---|----|---------------|------|----|-----|---------|---------|---------|---------|---------|
| armchair wide right | | | | | | | | | | |
|  | FC | E1649-0110-2S | 0,80 | 44 | 7,0 | 390 600 | 423 150 | 465 000 | 506 850 | 623 100 |



Sales pricelist 2024

UPHOLSTERY: fabric: FC - fix cover or LC - loose cover, COMFORTS: STD - standard Currency: EUR Valid from: 01.02.2024.

| DIMENSION* with legs H-80 mm | DESCRIPTION ARTICLE No | | VOL. | WEIGHT | FABRIC USAGE | I | II | III | IV | E |
|---------------------------------|---------------------------------------|----------------------|------|--------|-----------------|----------------|----------------|----------------|----------------|------------------|
| | LC | E1649-0110-6S | 0,80 | 44 | 7,0 | 423 150 | 465 000 | 511 500 | 548 700 | 683 550 |
| | COVER | E0649-0110-6 | 0,02 | 4 | 7,0 | 172 050 | 204 600 | 269 700 | 306 900 | 385 950 |
| 105x108x83/46 | armchair wide without armrests | | | | | | | | | |
| | FC | E1649-0130-2S | 0,80 | 32 | 6,0 | 316 200 | 348 750 | 385 950 | 413 850 | 516 150 |
| | LC | E1649-0130-6S | 0,80 | 32 | 6,0 | 348 750 | 381 300 | 418 500 | 455 700 | 562 650 |
| | COVER | E0649-0130-6 | 0,02 | 4 | 6,0 | 153 450 | 181 350 | 227 850 | 274 350 | 334 800 |
| 105x108x83/46 | armchair left | | | | | | | | | |
| | FC | E1649-0020-2S | 0,70 | 43 | 6,5 | 362 700 | 395 250 | 423 150 | 465 000 | 576 600 |
| | LC | E1649-0020-6S | 0,70 | 43 | 6,5 | 395 250 | 437 100 | 465 000 | 511 500 | 637 050 |
| | COVER | E0649-0020-6 | 0,02 | 4 | 6,5 | 158 100 | 195 300 | 241 800 | 292 950 | 367 350 |
| 105x108x83/46 | armchair right | | | | | | | | | |
| | FC | E1649-0010-2S | 0,70 | 43 | 6,5 | 362 700 | 395 250 | 423 150 | 465 000 | 576 600 |
| | LC | E1649-0010-6S | 0,70 | 43 | 6,5 | 395 250 | 437 100 | 465 000 | 511 500 | 637 050 |
| | COVER | E0649-0010-6 | 0,02 | 4 | 6,5 | 158 100 | 195 300 | 241 800 | 292 950 | 367 350 |
| 90x108x83/46 | armchair without armrests | | | | | | | | | |
| | FC | E1649-0030-2S | 0,60 | 31 | 5,3 | 292 950 | 325 500 | 353 400 | 381 300 | 465 000 |
| | LC | E1649-0030-6S | 0,60 | 31 | 5,0 | 325 500 | 353 400 | 390 600 | 413 850 | 516 150 |
| | COVER | E0649-0030-6 | 0,02 | 4 | 5,0 | 130 200 | 162 750 | 195 300 | 232 500 | 288 300 |
| 200/160x108x83/46 | corner 35° left ** | | | | | | | | | |
| | FC | E1649-1304-2S | 1,80 | 69 | 11,2 | 660 300 | 720 750 | 776 550 | 832 350 | 1 046 250 |
| | LC | E1649-1304-6S | 1,80 | 69 | 11,1 | 734 700 | 790 500 | 855 600 | 916 050 | 1 143 900 |
| | COVER | E0649-1304-6 | 0,02 | 7 | 11,1 | 265 050 | 334 800 | 413 850 | 502 200 | 618 450 |
| 200/160x108x83/46 | corner 35° right ** | | | | | | | | | |
| | FC | E1649-1305-2S | 1,80 | 69 | 11,2 | 660 300 | 720 750 | 776 550 | 832 350 | 1 046 250 |
| | LC | E1649-1305-6S | 1,80 | 69 | 11,1 | 734 700 | 790 500 | 855 600 | 916 050 | 1 143 900 |
| | COVER | E0649-1305-6 | 0,02 | 7 | 11,1 | 265 050 | 334 800 | 413 850 | 502 200 | 618 450 |
| 108x108x83/46 | corner 90° | | | | | | | | | |
| | FC | E1649-1302-2S | 0,76 | 35 | 7,6 | 478 950 | 530 100 | 567 300 | 623 100 | 771 900 |
| | LC | E1649-1302-6S | 0,76 | 35 | 7,6 | 530 100 | 571 950 | 623 100 | 678 900 | 850 950 |



Sales pricelist 2024

UPHOLSTERY: fabric: FC - fix cover or LC - loose cover, COMFORTS: STD - standard Currency: EUR Valid from: 01.02.2024.

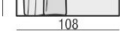
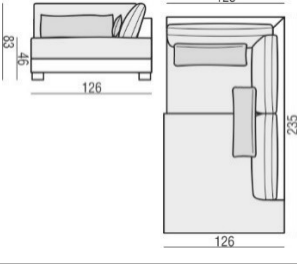
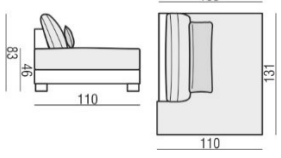
| DIMENSION* with legs H-80 mm | DESCRIPTION ARTICLE No | VOL. | WEIGHT | FABRIC USAGE | I | II | III | IV | E | |
|---|---------------------------|------|--------|-----------------|---------|---------|-----------|-----------|-----------|--|
|  | COVER E0649-1302-6 | 0,02 | 4 | 7,6 | 176 700 | 213 900 | 2 585 400 | 316 200 | 390 600 | |
| 126x235x83/46 divan left | | | | | | | | | | |
|  | FC E1649-1230-2S | 2,00 | 81 | 14,1 | 744 000 | 813 750 | 892 800 | 957 900 | 1 195 050 | |
| | LC E1649-1230-6S | 2,00 | 81 | 14,1 | 813 750 | 897 450 | 971 850 | 1 055 550 | 1 315 950 | |
| | COVER E0649-1230-6 | 0,04 | 8 | 14,1 | 306 900 | 413 850 | 511 500 | 604 500 | 753 300 | |
| 126x235x83/46 divan left (two parts) | | | | | | | | | | |
|  | FC E1649-1232-2S | 2,00 | 81 | 14,5 | 753 300 | 827 700 | 906 750 | 985 800 | 1 227 600 | |
| | LC E1649-1232-6S | 2,00 | 81 | 14,1 | 827 700 | 906 750 | 999 750 | 1 074 150 | 1 348 500 | |
| | COVER E0649-1232-6 | 0,04 | 8 | 14,1 | 316 200 | 418 500 | 530 100 | 623 100 | 771 900 | |
| 126x235x83/46 divan right | | | | | | | | | | |
|  | FC E1649-1231-2S | 2,00 | 81 | 14,1 | 744 000 | 813 750 | 892 800 | 957 900 | 1 195 050 | |
| | LC E1649-1231-6S | 2,00 | 81 | 14,1 | 813 750 | 897 450 | 971 850 | 1 055 550 | 1 315 950 | |
| | COVER E0649-1231-6 | 0,04 | 8 | 14,1 | 306 900 | 413 850 | 511 500 | 604 500 | 753 300 | |
| 126x235x83/46 divan right (two parts) | | | | | | | | | | |
|  | FC E1649-1233-2S | 2,00 | 81 | 14,5 | 753 300 | 827 700 | 906 750 | 985 800 | 1 227 600 | |
| | LC E1649-1233-6S | 2,00 | 81 | 14,1 | 827 700 | 906 750 | 999 750 | 1 074 150 | 1 348 500 | |
| | COVER E0649-1233-6 | 0,04 | 8 | 14,1 | 316 200 | 418 500 | 530 100 | 623 100 | 771 900 | |
| 110x131x83/46 bench left | | | | | | | | | | |
|  | FC E1649-1310-2S | 0,91 | 41 | 6,6 | 455 700 | 506 850 | 548 700 | 595 200 | 744 000 | |
| | LC E1649-1310-6S | 0,91 | 41 | 6,6 | 506 850 | 548 700 | 604 500 | 651 000 | 813 750 | |
| | COVER E0649-1310-6 | 0,02 | 4 | 6,6 | 190 650 | 265 050 | 316 200 | 381 300 | 465 000 | |
| 110x131x83/46 bench right | | | | | | | | | | |



Sales pricelist 2024

UPHOLSTERY: fabric: FC - fix cover or LC - loose cover, COMFORTS: STD - standard Currency: EUR Valid from: 01.02.2024.

| DIMENSION* with legs H-80 mm | DESCRIPTION ARTICLE No | VOL. | WEIGHT | FABRIC USAGE | I | II | III | IV | E |
|---------------------------------|---------------------------|------|--------|-----------------|----------------|----------------|----------------|----------------|----------------|
| | FC E1649-1311-2S | 0,91 | 41 | 6,6 | 455 700 | 506 850 | 548 700 | 595 200 | 744 000 |
| | LC E1649-1311-6S | 0,91 | 41 | 6,6 | 506 850 | 548 700 | 604 500 | 651 000 | 813 750 |
| | COVER E0649-1311-6 | 0,02 | 4 | 6,6 | 190 650 | 265 050 | 316 200 | 381 300 | 465 000 |

suggested sets:

| 345x108x83/46 | SET 1 - 3 seater l. + armchair wide r. | | | | | | | | |
|---------------|--|------|-----|------|------------------|------------------|------------------|------------------|------------------|
| | FC E1649-5121-2S | 2,40 | 118 | 19,1 | 1 046 250 | 1 134 600 | 1 241 550 | 1 339 200 | 1 674 000 |
| | LC E1649-5121-6S | 2,40 | 118 | 19,2 | 1 143 900 | 1 250 850 | 1 362 450 | 1 469 400 | 1 832 100 |
| | COVER E0649-5121-6 | 0,08 | 11 | 19,2 | 413 850 | 544 050 | 683 550 | 818 400 | 1 018 350 |

| 298/235x108x83/46 | SET 2 left - divan l. + 2 seater r. | | | | | | | | |
|-------------------|-------------------------------------|------|-----|------|------------------|------------------|------------------|------------------|------------------|
| | FC E1649-5208-2S | 3,10 | 145 | 24,3 | 1 288 050 | 1 408 950 | 1 534 500 | 1 664 700 | 2 083 200 |
| | LC E1649-5208-6S | 3,10 | 145 | 24,6 | 1 408 950 | 1 553 100 | 1 692 600 | 1 822 800 | 2 292 450 |
| | COVER E0649-5208-6 | 0,08 | 14 | 24,6 | 530 100 | 697 500 | 869 550 | 1 046 250 | 1 297 350 |

| 298/235x108x83/46 | SET 2 right - divan r. + 2 seater l. | | | | | | | | |
|-------------------|--------------------------------------|------|-----|------|------------------|------------------|------------------|------------------|------------------|
| | FC E1649-5207-2S | 3,10 | 145 | 24,3 | 1 288 050 | 1 408 950 | 1 534 500 | 1 664 700 | 2 083 200 |
| | LC E1649-5207-6S | 3,10 | 145 | 24,6 | 1 408 950 | 1 553 100 | 1 692 600 | 1 822 800 | 2 292 450 |
| | COVER E0649-5207-6 | 0,08 | 14 | 24,6 | 530 100 | 697 500 | 869 550 | 1 046 250 | 1 297 350 |

| 348/235x108x83/46 | SET 3 left - divan l. + 3 seater r. | | | | | | | | |
|-------------------|-------------------------------------|------|-----|------|------------------|------------------|------------------|------------------|------------------|
| | FC E1649-5408-2S | 3,50 | 156 | 26,1 | 1 390 350 | 1 520 550 | 1 664 700 | 1 799 550 | 2 236 650 |
| | LC E1649-5408-6S | 3,50 | 156 | 26,3 | 1 529 850 | 1 674 000 | 1 822 800 | 1 980 900 | 2 464 500 |
| | COVER E0649-5408-6 | 0,08 | 15 | 26,3 | 562 650 | 744 000 | 920 700 | 1 111 350 | 1 385 700 |

| 348/235x108x83/46 | SET 3 right - divan r. + 3 seater l. | | | | | | | | |
|-------------------|--------------------------------------|--|--|--|--|--|--|--|--|
|-------------------|--------------------------------------|--|--|--|--|--|--|--|--|



Sales pricelist 2024

UPHOLSTERY: fabric: FC - fix cover or LC - loose cover, COMFORTS: STD - standard Currency: EUR Valid from: 01.02.2024.

| DIMENSION* with legs H-80 mm | DESCRIPTION ARTICLE No | VOL. | WEIGHT | FABRIC USAGE | I | II | III | IV | E |
|---|---------------------------|------|--------|-----------------|------------------|------------------|------------------|------------------|------------------|
|  | FC E1649-5407-2S | 3,50 | 156 | 26,1 | 1 390 350 | 1 520 550 | 1 664 700 | 1 799 550 | 2 236 650 |
| | LC E1649-5407-6S | 3,50 | 156 | 26,3 | 1 529 850 | 1 674 000 | 1 822 800 | 1 980 900 | 2 464 500 |
| | COVER E0649-5407-6 | 0,08 | 15 | 26,3 | 562 650 | 744 000 | 920 700 | 1 111 350 | 1 385 700 |

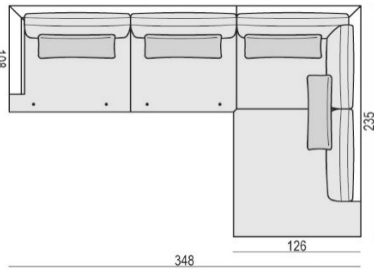
| 388/235x108x83/46 | SET 4 left - divan l. + armchair without armrests + 2 seater r. | | | | | | | | |
|--|---|------|-----|------|------------------|------------------|------------------|------------------|------------------|
|  | FC E1649-5266-2S | 3,60 | 176 | 29,5 | 1 567 050 | 1 725 150 | 1 883 250 | 2 022 750 | 2 534 250 |
| | LC E1649-5266-6S | 3,60 | 176 | 29,5 | 1 725 150 | 1 892 550 | 2 073 900 | 2 227 350 | 2 785 350 |
| | COVER E0649-5266-6 | 0,16 | 17 | 29,5 | 637 050 | 841 650 | 1 050 900 | 1 255 500 | 1 567 050 |

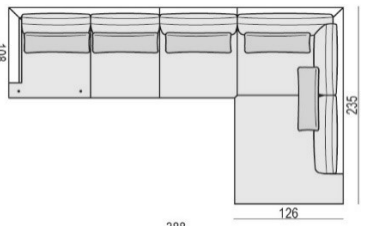
| 388/235x108x83/46 | SET 4 right - divan r. + armchair without armrests + 2 seater l. | | | | | | | | |
|---|--|------|-----|------|------------------|------------------|------------------|------------------|------------------|
|  | FC E1649-5264-2S | 3,60 | 176 | 29,5 | 1 567 050 | 1 725 150 | 1 883 250 | 2 022 750 | 2 534 250 |
| | LC E1649-5264-6S | 3,60 | 176 | 29,5 | 1 725 150 | 1 892 550 | 2 073 900 | 2 227 350 | 2 785 350 |
| | COVER E0649-5264-6 | 0,16 | 17 | 29,5 | 637 050 | 841 650 | 1 050 900 | 1 255 500 | 1 567 050 |

*Explicit +/- 2 cm tolerance of all elements sizes

**This element may have a stitching on the seat cushion. Ask your representative for more details.