

ASTA



SITS

design: Ian Archer

TECHNICAL SPECIFICATION

PROFILE

COMFORT: lux

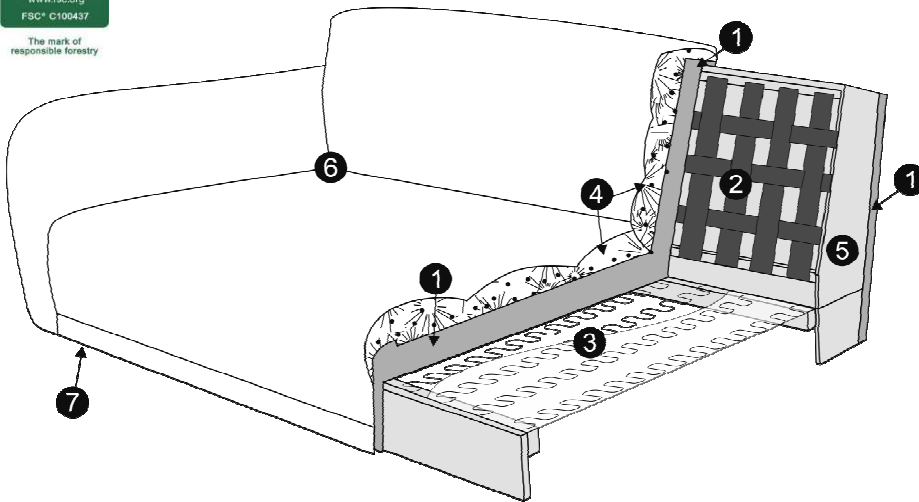

1	polyurethane foam/ high resilient polyurethane foam
2	upholstery belts
3	springs
4	cushion chamber with mix of feather and silicone balls
5	FSC® certified solid wood and wood based elements
6	fabric
7	plastic legs

COMFORT: lux - chaiselongue

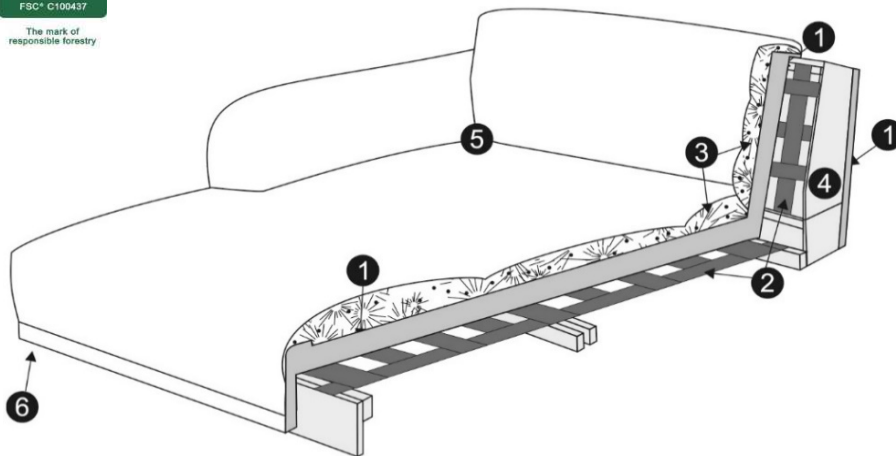

1	polyurethane foam/ high resilient polyurethane foam
2	upholstery belts
3	cushion chamber with mix of feather and silicone balls
4	FSC® certified solid wood and wood based elements
5	fabric
6	plastic legs

The producer reserves the right to change construction of products and compnents used due to improving durability of product and customer satisfaction without any further notice.

UPHOLSTERY:

fabric: FC - fix cover, Comfort: LUX

FEET

No. 37c plate

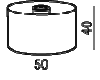

ASTA



SITS

design: Ian Archer

Sales Pricelist 2024

UPHOLSTERY: fabric: FC - fix cover COMFORT: lux

currency: HUF

Valid from: 01.01.2024

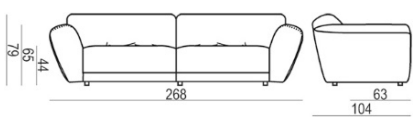
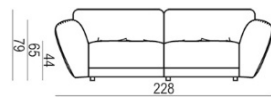
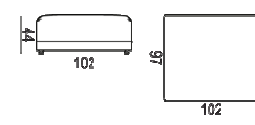
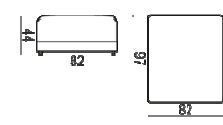
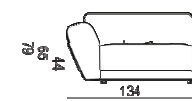
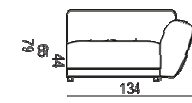
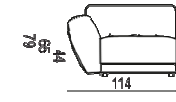
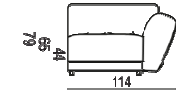
DIMENSION*	DESCRIPTION ARTICLE No	VOL.	WEIGHT	FABRIC USAGE	I	II	III	IV	E
268x104x79/44 4 seater divided									
	LUX E1646-0900-2L	2,27	92	10,5	940 800	1 009 400	1 087 800	1 146 600	1 430 800
228x104x79/44 3 seater divided									
	LUX E1646-0500-2L	1,94	86	10,5	891 800	960 400	1 038 800	1 097 600	1 372 000
102X97/44 footstool 102x97									
	LUX E1646-1060-2L	0,42	27	2,9	225 400	245 000	259 700	279 300	347 900
97X82/44 footstool 97x82									
	LUX E1646-1055-2L	0,33	22	2,9	215 600	230 300	245 000	264 600	328 300
elements for building sets:									
134x104x79/44 element 134 left									
	LUX E1646-0220-2L	1,14	46	5,3	470 400	504 700	543 900	573 300	715 400
134x104x79/44 element 134 right									
	LUX E1646-0210-2L	1,14	46	5,3	470 400	504 700	543 900	573 300	715 400
114x104x79/44 element 114 left									
	LUX E1646-0120-2L	0,97	43	5,3	445 900	480 200	519 400	548 800	686 000
114x104x79/44 element 114 right									
	LUX E1646-0110-2L	0,97	43	5,3	445 900	480 200	519 400	548 800	686 000

ASTA



SITS

design: Ian Archer

Sales Pricelist 2024

UPHOLSTERY: fabric: FC - fix cover COMFORT: lux

currency: HUF

Valid from: 01.01.2024

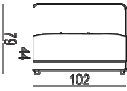
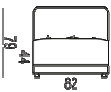
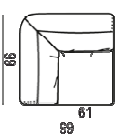
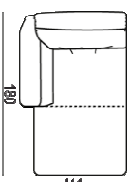
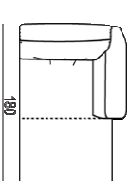
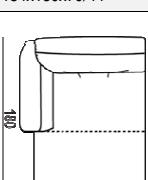
DIMENSION*	DESCRIPTION ARTICLE No	VOL.	WEIGHT	FABRIC USAGE	I	II	III	IV	E	
102x104x79/44	element 102 without armrests									
	LUX	E1646-0230-2L	0,87	34	3,8	357 700	382 200	406 700	426 300	534 100
82x104x79/44	element 82 without armrests									
	LUX	E1646-0130-2L	0,70	28	3,8	318 500	347 900	377 300	396 900	490 000
99x99x79/44	corner 90°									
	LUX	E1646-1302-2L	0,85	39	5,0	401 800	431 200	465 500	494 900	617 400
114x180x79/44	chaiselongue left**									
	LUX	E1646-1200-2L	1,70	59	6,5	578 200	617 400	661 500	700 700	872 200
114x180x79/44	chaiselongue right**									
	LUX	E1646-1210-2L	1,70	59	6,5	578 200	617 400	661 500	700 700	872 200
134x180x79/44	chaiselongue wide left**									
	LUX	E1646-1201-2L	1,95	69	6,5	607 600	646 800	695 800	735 000	916 300
134x180x79/44	chaiselongue wide right**									

ASTA



SITS

design: Ian Archer

Sales Pricelist 2024

UPHOLSTERY: fabric: FC - fix cover COMFORT: lux

currency: HUF

Valid from: 01.01.2024

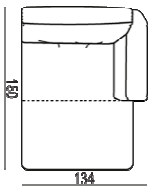
DIMENSION*	DESCRIPTION ARTICLE No	VOL.	WEIGHT	FABRIC USAGE	I	II	III	IV	E
	LUX E1646-1211-2L	1,95	69	6,5	607 600	646 800	695 800	735 000	916 300

suggested sets:

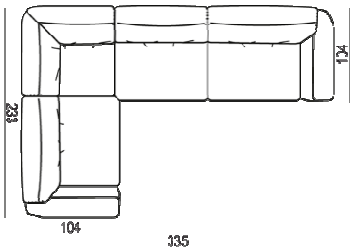
335/233x104x79/44	SET.1 left - element 134 l. + corner 90 + element 102 + element 134 r.									
	LUX	E1646-5701-2L	3,99	165	19,4	1 568 000	1 685 600	1 813 000	1 920 800	2 396 100

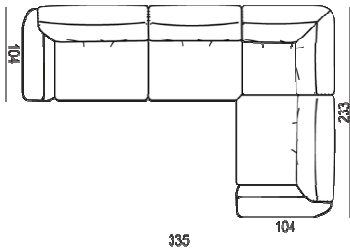
335/233x104x79/44	SET.1 right - element 134 r. + corner 90 + element 102 + element 134 l.									
	LUX	E1646-5700-2L	3,99	165	19,4	1 568 000	1 685 600	1 813 000	1 920 800	2 396 100

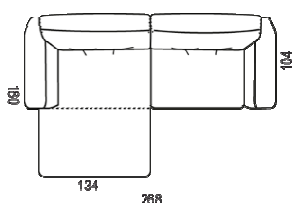
268/180x104x79/44	SET 2 left - chaiselongue wide l.** + element 134 r.									
	LUX	E1646-5206-2L	3,08	115	11,7	1 078 000	1 151 500	1 239 700	1 308 300	1 631 700

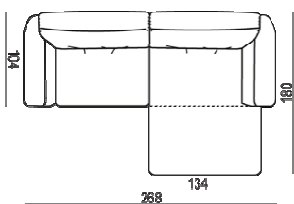
268/180x104x79/44	SET 2 right - chaiselongue wide r.** + element 134 l.									
	LUX	E1646-5205-2L	3,08	115	11,7	1 078 000	1 151 500	1 239 700	1 308 300	1 631 700

*Explicit +/- 2 cm tolerance of all elements sizes

ASTA



SITS

design: Ian Archer

Sales Pricelist 2024

UPHOLSTERY: fabric: FC - fix cover COMFORT: lux

currency: HUF

Valid from: 01.01.2024

DIMENSION*	DESCRIPTION ARTICLE No	VOL.	WEIGHT	FABRIC USAGE	I	II	III	IV	E
------------	---------------------------	------	--------	-----------------	---	----	-----	----	---

**This element may have a stitching on the seat cushion. Ask your representative for more details.

Załączone ceny rekomendowane mają charakter sugerowanych cen sprzedaży. Kupujący nie jest związany cenami rekomendowanymi.