

# IMPULSE

standard



**SITS**

design: SITS

## TECHNICAL SPECIFICATION

### PROFILE

COMFORT: STD - standard

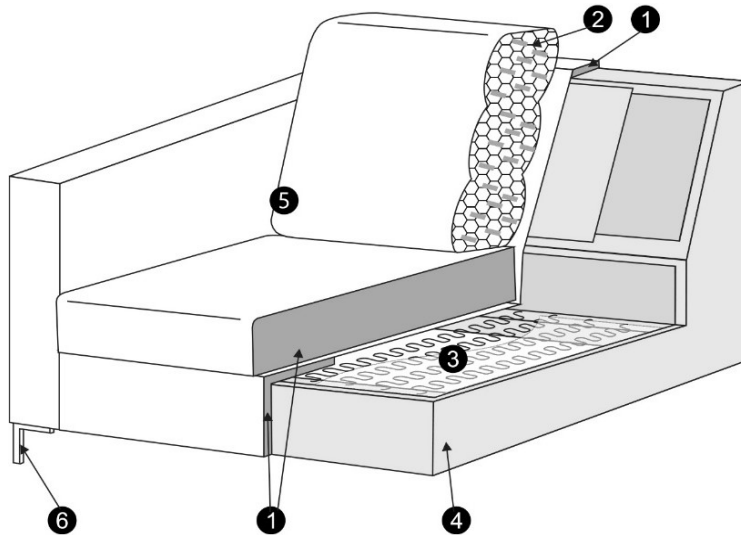

- |   |   |
|---|---|
| 1 | polyurethane foam/ high resilient polyurethane foam |
| 2 | foam flakes with silicone balls                     |
| 3 | springs   |
| 4 | solid wood and wood based elements                  |
| 5 | fabric  |
| 6 | metal (black,chrome) or solid wood legs             |

The producer reserves the right to change construction of products and compnents used due to improving durability of product and customer satisfaction without any further notice.

### UPHOLSTERY:

fabric: FC - fix cover, LC - loose cover or LCV - loose cover with velcro, leather: FC - fix cover  
COMFORT: STD - standard, PLUS - standard plus, CLS - classic or LUX

### ARMRESTS

**ARMREST I**  
cm 88 x 8 x 49 H

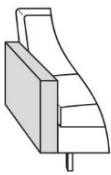

**ARMREST II**  
cm 88 x 15 x 49 H

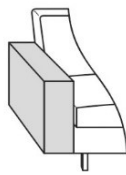

**ENDPART LEFT (or RIGHT)**  
cm 88 x 2,5 x 49 H

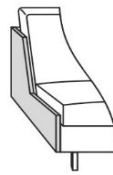

### TWO OPTIONS TO PLACE THE FEET

under armrest



under frame



### FEET

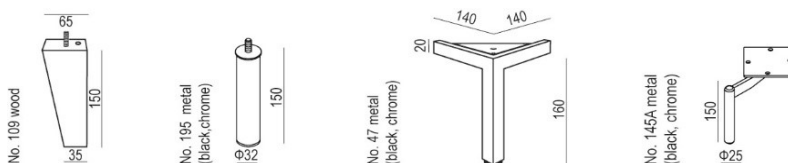

### COLOURS OF WOODEN FEET

IMPULSE  
standard



**SITS**

design: SITS

**TECHNICAL SPECIFICATION**

oak



bleached  
oak



walnut



black



IMPULSE  
standard



SITS

design: SITS

**Sales pricelist 2024**

UPHOLSTERY: fabric: FC - fix cover or LC - loose cover or LCV - loose cover with velcro  
COMFORT: STD - standard

Currency: EUR

Valid from: 01.02.2024.

DIMENSION * with armrest No I and legs H-150 mm	DESCRIPTION ARTICLE No	VOL.	WEIGHT	FABRIC USAGE	Currency: EUR					Valid from: 01.02.2024.	
					A	I	II	III	IV	E	
236x92x82/44	<b>4 seater (two parts)</b>										
	FC	E1758-0900-2S	1,35	94	9,8	609 150	646 350	697 500	757 950	823 050	1 027 650
	LC	E1758-0900-6S	1,35	94	9,8	674 250	711 450	771 900	837 000	906 750	1 139 250
	COVER	E0758-0900-6	0,04	6	9,8	209 250	260 400	283 650	306 900	330 150	413 850
	LCV	E1758-0900-4S	1,35	94	9,8	692 850	730 050	790 500	855 600	971 850	1 162 500
	COVER velcro	E0758-0900-4	0,04	6	9,8	195 300	274 350	292 950	320 850	344 100	427 800
218x92x82/44	<b>3 seater</b>										
	FC	E1758-0400-2S	1,25	58	9,2	506 850	544 050	604 500	674 250	734 700	916 050
	LC	E1758-0400-6S	1,25	58	9,2	562 650	599 850	674 250	734 700	813 750	1 009 050
	COVER	E0758-0400-6	0,04	8	9,2	218 550	218 550	241 800	274 350	292 950	362 700
	LCV	E1758-0400-4S	1,25	58	9,2	571 950	609 150	683 550	753 300	832 350	1 041 600
	COVER velcro	E0758-0400-4	0,04	8	9,2	209 250	223 200	246 450	279 000	302 250	372 000
196x92x82/44	<b>2,5 seater</b>										
	FC	E1758-0300-2S	1,14	57	8,5	465 000	488 250	562 650	618 450	678 900	846 300
	LC	E1758-0300-6S	1,14	57	8,5	511 500	548 700	618 450	678 900	753 300	943 950
	COVER	E0758-0300-6	0,04	5	8,5	195 300	195 300	223 200	246 450	279 000	334 800
	LCV	E1758-0300-4S	1,14	57	8,5	530 100	562 650	632 400	697 500	776 550	957 900
	COVER velcro	E0758-0300-4	0,04	5	8,5	190 650	204 600	227 850	255 750	283 650	348 750
156x92x82/44	<b>2 seater</b>										
	FC	E1758-0200-2S	0,90	47	7,2	432 450	455 700	506 850	562 650	618 450	771 900
	LC	E1758-0200-6S	0,90	47	7,2	469 650	506 850	562 650	618 450	678 900	846 300
	COVER	E0758-0200-6	0,02	4	7,2	186 000	186 000	204 600	223 200	246 450	306 900
	LCV	E1758-0200-4S	0,90	47	7,2	483 600	511 500	571 950	632 400	697 500	864 900
	COVER velcro	E0758-0200-4	0,02	4	7,2	181 350	190 650	209 250	227 850	255 750	311 550
81x92x82/44	<b>armchair</b>										
	FC	E1758-0000-2S	0,50	31	4,5	302 250	320 850	344 100	381 300	423 150	525 450
	LC	E1758-0000-6S	0,50	31	4,5	325 500	353 400	381 300	423 150	465 000	576 600
	COVER	E0758-0000-6	0,02	3	4,5	130 200	130 200	153 450	162 750	176 700	209 250
	LCV	E1758-0000-4S	0,50	31	4,5	330 150	362 700	385 950	432 450	469 650	595 200
	COVER velcro	E0758-0000-4	0,02	3	4,5	120 900	139 500	158 100	167 400	176 700	218 550
64x80x44	<b>footstool</b>										

IMPULSE  
standard



SITS

design: SITS

### Sales pricelist 2024

UPHOLSTERY: fabric: FC - fix cover or LC - loose cover or LCV - loose cover with velcro  
COMFORT: STD - standard

Currency: EUR

Valid from: 01.02.2024.

DIMENSION * with armrest No I and legs H-150 mm	DESCRIPTION ARTICLE No	VOL.	WEIGHT	FABRIC USAGE	A	I	II	III	IV	E
	FC <b>E1758-1045-2S</b>	0,20	12	1,7	176 700	186 000	204 600	209 250	227 850	288 300
	LC <b>E1758-1045-6S</b>	0,20	12	1,7	190 650	204 600	223 200	241 800	260 400	320 850
	COVER <b>E0758-1045-6</b>	0,01	1	1,7	79 050	79 050	83 700	88 350	93 000	120 900
	LCV <b>E1758-1045-4S</b>	0,20	12	1,7	195 300	204 600	223 200	241 800	260 400	325 500
	COVER velcro <b>E0758-1045-4</b>	0,01	1	1,7	79 050	79 050	83 700	88 350	97 650	120 900

60xØ16x62	headrest 60/16 with roll (foam filling)									
	LC <b>E1826-1660-4</b>	0,10	3	0,7	79 050	88 350	93 000	106 950	106 950	130 200
	COVER <b>E0826-1660-4</b>	0,01	1	0,7	51 150	51 150	51 150	55 800	55 800	60 450

56x7x25	cushion									
	LC <b>E1758-5625-4</b>	0,01	1	0,8	65 100	74 400	74 400	79 050	88 350	106 950
	COVER <b>E0758-5625-4</b>	0,01	1	0,8	41 850	46 500	46 500	46 500	51 150	55 800

armrest protection / set of 2										
	LC <b>E1758-1900-0</b>	0,01	1	0,7	46 500	46 500	55 800	60 450	65 100	88 350

#### elements for building sets:

228x92x82/44	4 seater left									
	FC <b>E1758-0920-2S</b>	1,31	88	9,3	544 050	571 950	632 400	683 550	734 700	920 700
	LC <b>E1758-0920-6S</b>	1,31	88	9,3	599 850	637 050	692 850	753 300	813 750	1 009 050
	COVER <b>E0758-0920-6</b>	0,04	6	9,3	232 500	227 850	246 450	279 000	292 950	362 700
	LCV <b>E1758-0920-4S</b>	1,31	88	9,3	627 750	660 300	711 450	776 550	841 650	1 046 250
	COVER velcro <b>E0758-0920-4</b>	0,04	6	9,3	223 200	232 500	255 750	283 650	302 250	372 000

228x92x82/44	4 seater right									
	FC <b>E1758-0910-2S</b>	1,31	88	9,3	544 050	571 950	632 400	683 550	734 700	920 700
	LC <b>E1758-0910-6S</b>	1,31	88	9,3	599 850	637 050	692 850	753 300	813 750	1 009 050
	COVER <b>E0758-0910-6</b>	0,04	6	9,3	232 500	227 850	246 450	279 000	292 950	362 700
	LCV <b>E1758-0910-4S</b>	1,31	88	9,3	627 750	660 300	711 450	776 550	841 650	1 046 250
	COVER velcro <b>E0758-0910-4</b>	0,04	6	9,3	223 200	232 500	255 750	283 650	302 250	372 000

220x92x82/44	4 seater without armrests									
	FC <b>E1758-0930-2S</b>	1,26	77	8,3	483 600	506 850	558 000	599 850	655 650	813 750

IMPULSE  
standard



SITS

design: SITS

### Sales pricelist 2024

UPHOLSTERY: fabric: FC - fix cover or LC - loose cover or LCV - loose cover with velcro  
COMFORT: STD - standard

Currency: EUR

Valid from: 01.02.2024.

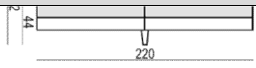
DIMENSION * with armrest No I and legs H-150 mm	DESCRIPTION ARTICLE No	VOL.	WEIGHT	FABRIC USAGE							
					A	I	II	III	IV	E	
	LC	E1758-0930-6S	1,26	77	8,3	539 400	562 650	604 500	660 300	720 750	902 100
	COVER	E0758-0930-6	0,04	5	8,3	209 250	204 600	218 550	232 500	260 400	325 500
	LCV	E1758-0930-4S	1,26	77	8,3	562 650	585 900	632 400	683 550	744 000	934 650
	COVER velcro	E0758-0930-4	0,04	5	8,3	195 300	209 250	223 200	246 450	274 350	330 150

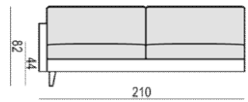
210x92x82/44	3 seater left										
	FC	E1758-0420-2S	1,21	53	8,3	427 800	441 750	497 550	544 050	599 850	744 000
	LC	E1758-0420-6S	1,21	53	8,3	465 000	488 250	558 000	599 850	660 300	823 050
	COVER	E0758-0420-6	0,04	5	8,3	186 000	181 350	195 300	218 550	232 500	292 950
	LCV	E1758-0420-4S	1,21	53	8,3	483 600	506 850	571 950	627 750	683 550	855 600
	COVER velcro	E0758-0420-4	0,04	5	8,3	181 350	186 000	204 600	223 200	246 450	306 900

210x92x82/44	3 seater right										
	FC	E1758-0410-2S	1,21	53	8,3	427 800	441 750	497 550	544 050	599 850	744 000
	LC	E1758-0410-6S	1,21	53	8,3	465 000	488 250	558 000	599 850	660 300	823 050
	COVER	E0758-0410-6	0,04	5	8,3	186 000	181 350	195 300	218 550	232 500	292 950
	LCV	E1758-0410-4S	1,21	53	8,3	483 600	506 850	571 950	627 750	683 550	855 600
	COVER velcro	E0758-0410-4	0,04	5	8,3	181 350	186 000	204 600	223 200	246 450	306 900

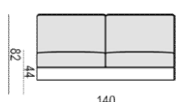
202x92x82/44	3 seater without armrests										
	FC	E1758-0430-2S	1,16	47	7,6	362 700	385 950	432 450	469 650	530 100	655 650
	LC	E1758-0430-6S	1,16	47	7,6	404 550	427 800	469 650	530 100	571 950	720 750
	COVER	E0758-0430-6	0,04	4	7,6	167 400	162 750	176 700	190 650	209 250	260 400
	LCV	E1758-0430-4S	1,16	47	7,6	413 850	437 100	488 250	539 400	599 850	744 000
	COVER velcro	E0758-0430-4	0,04	4	7,6	162 750	167 400	181 350	195 300	218 550	274 350

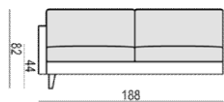
188x92x82/44	2,5 seater left										
	FC	E1758-0320-2S	1,08	50	7,6	404 550	427 800	465 000	511 500	562 650	697 500
	LC	E1758-0320-6S	1,08	50	7,6	437 100	465 000	511 500	567 300	627 750	771 900
	COVER	E0758-0320-6	0,04	5	7,6	176 700	176 700	186 000	204 600	223 200	279 000
	LCV	E1758-0320-4S	1,08	50	7,6	455 700	483 600	534 750	595 200	646 350	795 150
	COVER velcro	E0758-0320-4	0,04	5	7,6	172 050	181 350	190 650	209 250	227 850	288 300

188x92x82/44	2,5 seater right										
	FC	E1758-0310-2S	1,08	50	7,6	404 550	427 800	465 000	511 500	562 650	697 500



**Sales pricelist 2024**

UPHOLSTERY: fabric: FC - fix cover or LC - loose cover or LCV - loose cover with velcro  
COMFORT: STD - standard

Currency: EUR

Valid from: 01.02.2024.

DIMENSION * with armrest No I and legs H-150 mm	DESCRIPTION ARTICLE No	VOL.	WEIGHT	FABRIC USAGE	A	I	II	III	IV	E
	LC E1758-0310-6S	1,08	50	7,6	437 100	465 000	511 500	567 300	627 750	771 900
	COVER E0758-0310-6	0,04	5	7,6	176 700	176 700	186 000	204 600	223 200	279 000
	LCV E1758-0310-4S	1,08	50	7,6	455 700	483 600	534 750	595 200	646 350	795 150
	COVER velcro E0758-0310-4	0,04	5	7,6	172 050	181 350	190 650	209 250	227 850	288 300

180x92x82/44	2,5 seater without armrests									
	FC E1758-0330-2S	1,04	42	6,9	325 500	344 100	399 900	432 450	469 650	595 200
	LC E1758-0330-6S	1,04	42	6,9	353 400	385 950	432 450	469 650	530 100	655 650
	COVER E0758-0330-6	0,04	4	6,9	153 450	153 450	167 400	176 700	190 650	232 500
	LCV E1758-0330-4S	1,04	42	6,9	367 350	404 550	441 750	488 250	539 400	674 250
	COVER velcro E0758-0330-4	0,04	4	6,9	139 500	158 100	167 400	181 350	195 300	241 800

148x92x82/44	2 seater left									
	FC E1758-0220-2S	0,90	39	6,3	344 100	367 350	409 200	441 750	483 600	604 500
	LC E1758-0220-6S	0,90	39	6,3	385 950	409 200	455 700	488 250	539 400	669 600
	COVER E0758-0220-6	0,04	4	6,3	162 750	158 100	172 050	181 350	195 300	241 800
	LCV E1758-0220-4S	0,90	39	6,3	404 550	427 800	465 000	506 850	562 650	692 850
	COVER velcro E0758-0220-4	0,04	4	6,3	158 100	162 750	176 700	186 000	195 300	246 450

148x92x82/44	2 seater right									
	FC E1758-0210-2S	0,90	39	6,3	344 100	367 350	409 200	441 750	483 600	604 500
	LC E1758-0210-6S	0,90	39	6,3	385 950	409 200	455 700	488 250	539 400	669 600
	COVER E0758-0210-6	0,04	4	6,3	162 750	158 100	172 050	181 350	195 300	241 800
	LCV E1758-0210-4S	0,90	39	6,3	404 550	427 800	465 000	506 850	562 650	692 850
	COVER velcro E0758-0210-4	0,04	4	6,3	158 100	162 750	176 700	186 000	195 300	246 450

140x92x82/44	2 seater without armrests									
	FC E1758-0230-2S	0,81	37	5,5	279 000	292 950	330 150	362 700	404 550	497 550
	LC E1758-0230-6S	0,81	37	5,5	306 900	325 500	367 350	404 550	437 100	558 000
	COVER E0758-0230-6	0,04	4	5,5	120 900	120 900	139 500	158 100	167 400	195 300
	LCV E1758-0230-4S	0,81	37	5,5	325 500	334 800	385 950	413 850	455 700	571 950
	COVER velcro E0758-0230-4	0,04	4	5,5	116 250	120 900	153 450	162 750	172 050	204 600

92x185x82/44	divan left									
	FC E1758-1230-2S	1,18	47	7,8	427 800	441 750	488 250	539 400	595 200	734 700
	LC E1758-1230-6S	1,18	47	7,8	465 000	488 250	544 050	595 200	655 650	813 750



Sales pricelist 2024

UPHOLSTERY: fabric: FC - fix cover or LC - loose cover or LCV - loose cover with velcro  
COMFORT: STD - standard

Currency: EUR

Valid from: 01.02.2024.

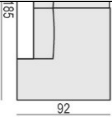
DIMENSION * with armrest No I and legs H-150 mm	DESCRIPTION ARTICLE No	VOL.	WEIGHT	FABRIC USAGE	A	I	II	III	IV	E	
	COVER	E0758-1230-6	0,04	5	7,8	186 000	181 350	195 300	218 550	232 500	292 950
	LCV	E1758-1230-4S	1,18	47	7,8	483 600	506 850	567 300	609 150	674 250	841 650
	COVER velcro	E0758-1230-4	0,04	5	7,8	181 350	186 000	204 600	223 200	241 800	302 250

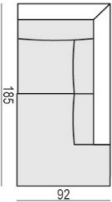
92x185x82/44	divan right										
	FC	E1758-1231-2S	1,18	47	7,8	427 800	441 750	488 250	539 400	595 200	734 700
	LC	E1758-1231-6S	1,18	47	7,8	465 000	488 250	544 050	595 200	655 650	813 750
	COVER	E0758-1231-6	0,04	5	7,8	186 000	181 350	195 300	218 550	232 500	292 950
	LCV	E1758-1231-4S	1,18	47	7,8	483 600	506 850	567 300	609 150	674 250	841 650
	COVER velcro	E0758-1231-4	0,04	5	7,8	181 350	186 000	204 600	223 200	241 800	302 250

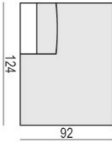
92x124x82/44	bench left										
	FC	E1758-1310-2S	0,70	35	4,5	279 000	292 950	325 500	344 100	372 000	465 000
	LC	E1758-1310-6S	0,70	35	4,5	306 900	325 500	353 400	385 950	413 850	511 500
	COVER	E0758-1310-6	0,04	3	4,5	120 900	120 900	130 200	153 450	162 750	186 000
	LCV	E1758-1310-4S	0,70	35	4,5	325 500	334 800	367 350	404 550	432 450	534 750
	COVER velcro	E0758-1310-4	0,04	3	4,5	116 250	120 900	139 500	158 100	162 750	190 650

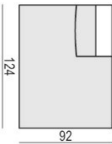
92x124x82/44	bench right										
	FC	E1758-1311-2S	0,70	35	4,5	279 000	292 950	325 500	344 100	372 000	465 000
	LC	E1758-1311-6S	0,70	35	4,5	306 900	325 500	353 400	385 950	413 850	511 500
	COVER	E0758-1311-6	0,04	3	4,5	120 900	120 900	130 200	153 450	162 750	186 000
	LCV	E1758-1311-4S	0,70	35	4,5	325 500	334 800	367 350	404 550	432 450	534 750
	COVER velcro	E0758-1311-4	0,04	3	4,5	116 250	120 900	139 500	158 100	162 750	190 650

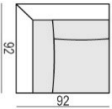
92x92x82/44	corner 90°										
	FC	E1758-1302-2S	0,51	27	4,4	279 000	288 300	311 550	334 800	362 700	455 700
	LC	E1758-1302-6S	0,51	27	4,4	306 900	311 550	344 100	372 000	404 550	497 550
	COVER	E0758-1302-6	0,02	3	4,4	120 900	116 250	130 200	153 450	158 100	181 350
	LCV	E1758-1302-4S	0,51	27	4,4	325 500	330 150	362 700	399 900	413 850	511 500
	COVER velcro	E0758-1302-4	0,02	3	4,4	116 250	120 900	130 200	153 450	162 750	186 000

88x49x2,5	endpart left										
-----------	--------------	--	--	--	--	--	--	--	--	--	--

IMPULSE  
standard



SITS

design: SITS

### Sales pricelist 2024

UPHOLSTERY: fabric: FC - fix cover or LC - loose cover or LCV - loose cover with velcro  
COMFORT: STD - standard

Currency: EUR

Valid from: 01.02.2024.

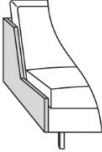
DIMENSION * with armrest No I and legs H-150 mm	DESCRIPTION ARTICLE No	VOL.	WEIGHT	FABRIC USAGE	A	I	II	III	IV	E
	FC E1758-1960-2	0,02	3	1,1	74 400	79 050	83 700	93 000	97 650	120 900

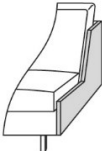
88x49x2,5	endpart right									
	FC E1758-1950-2	0,02	3	1,1	74 400	79 050	83 700	93 000	97 650	120 900

#### suggested sets:

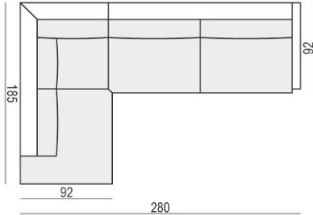
282/185x92x82/44	SET 4 left - 2,5 seater r. + divan l.									
	FC E1758-5308-2S	2,20	96	15,4	837 000	897 450	1 004 400	1 106 700	1 218 300	1 515 900
	LC E1758-5308-6S	2,20	96	15,4	916 050	990 450	1 106 700	1 218 300	1 343 850	1 674 000
	COVER E0758-5308-6	0,08	9	15,4	348 750	348 750	399 900	437 100	469 650	595 200
	LCV E1758-5308-4S	2,20	96	15,4	939 300	1 004 400	1 125 300	1 241 550	1 362 450	1 701 900
	COVER velcro E0758-5308-4	0,08	9	15,4	334 800	362 700	409 200	446 400	488 250	609 150

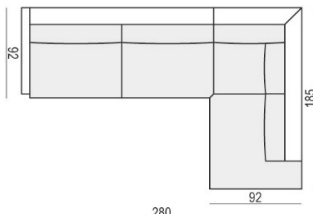
282/185x92x82/44	SET 4 right - 2,5 seater l. + divan r.									
	FC E1758-5307-2S	2,20	96	15,4	837 000	897 450	1 004 400	1 106 700	1 218 300	1 515 900
	LC E1758-5307-6S	2,20	96	15,4	916 050	990 450	1 106 700	1 218 300	1 343 850	1 674 000
	COVER E0758-5307-6	0,08	9	15,4	348 750	348 750	399 900	437 100	469 650	595 200
	LCV E1758-5307-4S	2,20	96	15,4	939 300	1 004 400	1 125 300	1 241 550	1 362 450	1 701 900
	COVER velcro E0758-5307-4	0,08	9	15,4	334 800	362 700	409 200	446 400	488 250	609 150

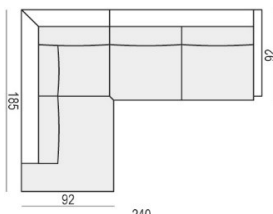
240/185x92x82/44	SET 5 left - 2 seater r. + divan l.									
	FC E1758-5208-2S	1,90	88	14,0	771 900	813 750	916 050	1 009 050	1 116 000	1 395 000
	LC E1758-5208-6S	1,90	88	14,0	841 650	902 100	1 009 050	1 116 000	1 227 600	1 529 850
	COVER E0758-5208-6	0,08	8	14,0	325 500	325 500	362 700	404 550	437 100	544 050
	LCV E1758-5208-4S	1,90	88	14,0	860 250	916 050	1 027 650	1 129 950	1 250 850	1 557 750
	COVER velcro E0758-5208-4	0,08	8	14,0	311 550	330 150	372 000	413 850	446 400	558 000

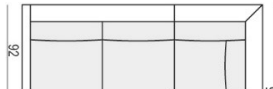
240/185x92x82/44	SET 5 right - 2 seater l. + divan r.									
	FC E1758-5207-2S	1,90	88	14,0	771 900	813 750	916 050	1 009 050	1 116 000	1 395 000
	LC E1758-5207-6S	1,90	88	14,0	841 650	902 100	1 009 050	1 116 000	1 227 600	1 529 850



IMPULSE  
standard



SITS

design: SITS

**Sales pricelist 2024**

UPHOLSTERY: fabric: FC - fix cover or LC - loose cover or LCV - loose cover with velcro  
COMFORT: STD - standard

Currency: EUR

Valid from: 01.02.2024.

DIMENSION * with armrest No I and legs H-150 mm	DESCRIPTION ARTICLE No	VOL.	WEIGHT	FABRIC USAGE	Currency: EUR					
					A	I	II	III	IV	E
	COVER <b>E0758-5207-6</b>	0,08	8	14,0	<b>325 500</b>	<b>325 500</b>	<b>362 700</b>	<b>404 550</b>	<b>437 100</b>	<b>544 050</b>
	LCV <b>E1758-5207-4S</b>	1,90	88	14,0	<b>860 250</b>	<b>916 050</b>	<b>1 027 650</b>	<b>1 129 950</b>	<b>1 250 850</b>	<b>1 557 750</b>
	COVER velcro <b>E0758-5207-4</b>	0,08	8	14,0	<b>311 550</b>	<b>330 150</b>	<b>372 000</b>	<b>413 850</b>	<b>446 400</b>	<b>558 000</b>

\*Explicit +/- 2 cm tolerance of all elements sizes