

# CLARK

LEATHER

cocktail&design



**SITS**  
— comfortable life

design: Niels Gammelgaard

## TECHNICAL SPECIFICATION

### PROFILE

COMFORT: standard

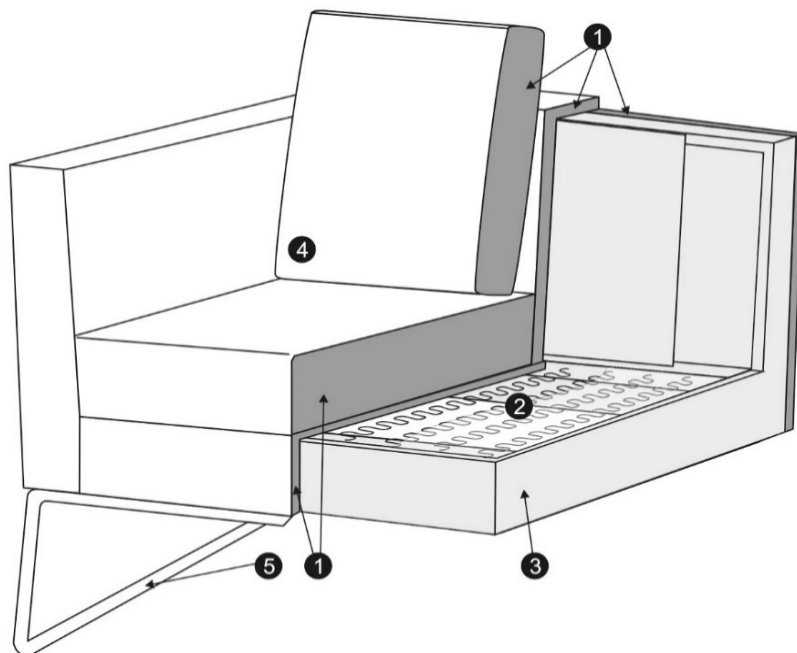

1	polyurethane foam/ high resilient polyurethane foam
2	springs
3	solid wood and wood based elements
4	leather
5	metal frame (black, grey or chrome)

The producer reserves the right to change construction of products and components used due to improving durability of product and customer satisfaction without any further notice.

### UPHOLSTERY:

leather or fabric: FC - fix cover, COMFORT: STD - standard

### FEET

CHAIR

METAL FRAME:  
chrome and painted  
black or grey

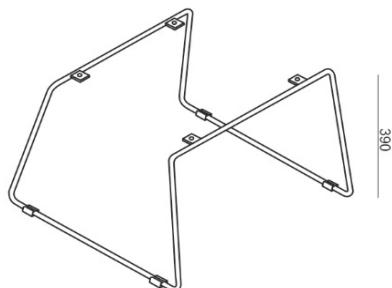

ARMCHAIR, SOFA

METAL FRAME:  
chrome and painted  
black or grey

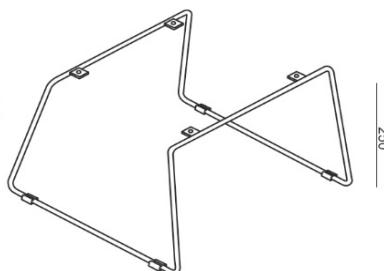

CLARK  
LEATHER

SITS  
— comfortable life



cocktail&design

design: Niels Gammelgaard



## Sales pricelist 2022

UPHOLSTERY: leather: FC - fix cover

COMFORT: STD - standard

EUR

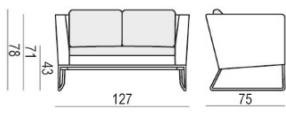
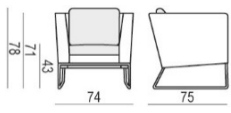
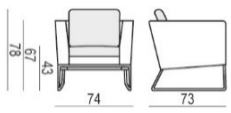
Valid from: 01.04.2022

DIMENSION*	DESCRIPTION ARTICLE No	VOL.	WEIGHT	LEATHER USAGE	MATRIX	TOUCH	ANILINE
127x75x78/43 	<b>2 seater</b>  E2553-0200-2S	0,90	33	x	744 800	896 700	1 146 600
74x75x78/43 	<b>armchair</b>  E2553-0000-2S	0,50	23	x	465 500	563 500	788 900
74x73x78/43 	<b>armchair low</b>  E2553-0001-2S	0,50	23	x	465 500	563 500	730 100
60x60x89/49 	<b>chair with armrests</b>  E2553-1501-2S	0,40	15	x	254 800	308 700	347 900
50x64x89/49 	<b>chair without armrests</b>  E2553-1500-2S	0,40	15	x	220 500	274 400	323 400

\*Explicit +/- 2 cm tolerance of all elements sizes